



KORSON
 FURNITURE DESIGN

resimercial
 Furniture

DESIGN FOR TODAY

 double corner blocks: glued & screwed

 high density foam seats: contract quality

 **so**
461

locklear

lounge chair **so46113**

create a personal oasis of comfort with this extravagant lounge chair enhanced by sophisticated retro aesthetics. quirky and hip, this low-back lounge chair is made with a soft rich upholstery, and begs you to get lost in its warmth.



Cover: *Velour*.
Colour: *Mustard*.
Finish: *Brass Titanized
Stainless Steel*.

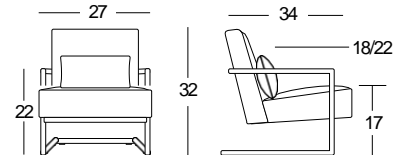

carton size: overall: 29"w 28"d 18"h

carton Weight: 32 lbs

carton cube: 17.05cu.ft.

Packed: 1 item/carton

lounge chair overall: 27"w 34"d 32"h. seat: 18"d 17"h. arm: 22"h

 double corner blocks: glued & screwed

 high density foam seats: contract quality

 **so**
461

locklear

lounge chair **so46141**

The 1960s were clean sophisticated, and inclusive. despite the passage of time, retro designs have remained a staple in interior architecture. perhaps the most noticeable aspect of the locklear lounge chair is its dual-natured look: minimalistic, whimsy and organic.



Cover: *Velour*.
Colour: *Indigo*.
Finish: *Brass Titanized
Stainless Steel*.

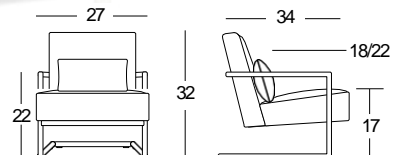

carton size: overall: 29"w 28"d 18"h

carton Weight: 32 lbs

carton cube: 17.05cu.ft.

Packed: 1 item/carton

lounge chair overall: 27"w 34"d 32"h. seat: 18"d 17"h. arm: 22"h

 double corner blocks: glued & screwed

 high density foam seats: contract quality

 461

locklear

lounge chair **so46108**

create a personal oasis of comfort with this extravagant lounge chair enhanced by sophisticated retro aesthetics. quirky and hip, this low-back lounge chair is made with a soft rich upholstery, and begs you to get lost in its warmth.



*Cover: Velour.
Colour: Scarlet.
Finish: Brass Titanized
Stainless Steel.*

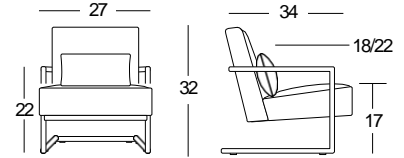

carton size: overall: 29"w 28"d 18"h

carton Weight: 32 lbs

carton cube: 17.05cu.ft.

Packed: 1 item/carton

lounge chair overall: 27"w 34"d 32"h. seat: 18"d 17"h. arm: 22"h

 double corner blocks: glued & screwed

 high density foam seats: contract quality

 1506

inaba

club chair **sup1506**

create a personal oasis of comfort with this extravagant lounge chair enhanced by sophisticated retro aesthetics. quirky and hip, this low-back lounge chair is made with a soft rich upholstery, and begs you to get lost in its warmth.



*Cover: Tweed.
Colour: Pebble.
Finish: Polished
Stainless Steel.*

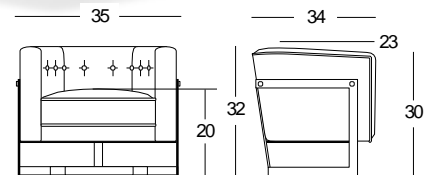

carton size: overall: 36"w 32"d 34"h

carton Weight: 70 lbs

carton cube: 22.67cu.ft.

Packed: 1 item/carton

lounge chair overall: 35"w 34"d 32"h. seat: 23"d 20"h. arm: 30"h

resimercial
Furniture

DESIGN FOR TODAY

 double corner blocks: glued & screwed

 high density foam seats: contract quality

svk
1191

sundrine

lounge chair **svk119108**

This lounge chair offers a quick and easy way to finish a room. with its deluxe seat cushion and low sloping back, the chair wraps your body with the soft support it needs to relax. wherever style is key, mix and match in melodic synchronicity.



Cover: Keystone.
Colour: Dim Gray
Finish: Brass
Anodized Steel.

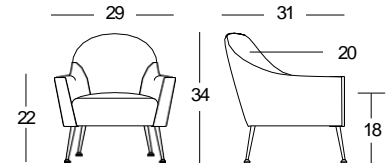

carton size: overall: 30" w 31" d 25" h

carton Weight: 34 lbs

carton cube: 10.24 cu. ft.

Packed: 1 item/carton

lounge chair overall: 29" w 31" d 34" h. seat: 20" d 18" h. arm: 22" h

 double corner blocks: glued & screwed

 high density foam seats: contract quality

svk
1191

sundrine

lounge chair **svk119058**

create a personal oasis of comfort with this extravagant lounge chair enhanced by sophisticated retro aesthetics. quirky and hip, this curved-back lounge chair is made with a soft rich upholstery, and begs you to get lost in its warmth.



Cover: Keystone.
Colour: Ebony.
Finish: Brass
Anodized Steel.

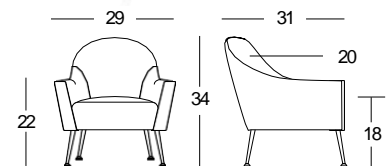

carton size: overall: 30" w 31" d 25" h

carton Weight: 34 lbs

carton cube: 10.24 cu. ft.

Packed: 1 item/carton

lounge chair overall: 29" w 31" d 34" h. seat: 20" d 18" h. arm: 22" h

 double corner blocks: glued & screwed

 high density foam seats: contract quality

sha
175

arne

lounge chairs

extremely comfortable and luxurious, uniquely modern and gorgeously enhanced by sophisticated retro aesthetics. quirky, hip, this exaggerated lounge chair has a flared curved back with arms that slope toward the seat. loose cushion seat, low back, sleigh legs, sits extremely comfortably.



sha17508

Cover: Doni. Colour: Sky.
Finish: Brass Anodized Steel.

sha17514

Cover: Doni. Colour: Pebble.
Finish: Brass Anodized Steel.

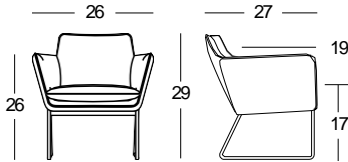

carton size: overall: 28" w 26" d 24" h

carton Weight: 44 lbs

carton cube: 10.59 cu.ft.

Packed: 1 item/carton

lounge chair overall: 26" w 27" d 29" h. seat: 19" d 17" h. arm: 26" h

 double corner blocks: glued & screwed

 high density foam seats: contract quality

sup
5596

anderson

lounge chair **sup5596**

The 1960s were clean sophisticated, and inclusive. despite the passage of time, retro designs have remained a staple in interior architecture. perhaps the most noticeable aspect of the anderson lounge chair is its dual-natured look: minimalistic, whimsy and organic.



Cover: Tweed.
Colour: Pebble.
Finish: Polished
Stainless Steel.

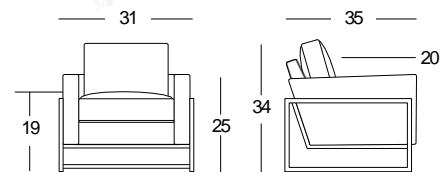

carton size: overall: 34" w 31" d 30" h

carton Weight: 64 lbs

carton cube: 20.54 cu.ft.

Packed: 1 item/carton

lounge chair overall: 31" w 35" d 34" h. seat: 20" d 19" h. arm: 25" h

 double corner blocks: glued & screwed

 high density foam seats: contract quality

so
676

roger

lounge chair **so6762**

This lounge features a spacious mid century wooden frame with fluid armrests that gently slope up and provide a comfortable, stylish place to rest your arms. This modern chair uses an expertly bench-crafted solid wood frame to support the large high density tufted seat and back. The crisp and organic lines flow from front to back and create an artistic contemporary addition to any space.



Cover: Synthetic Leather. Colour: Vintage Brown. Finish: Walnut.

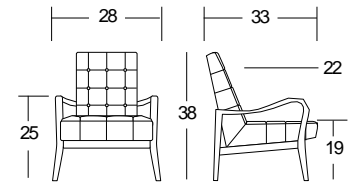

carton size: overall: 30" w 34" d 41" h

carton Weight: 53 lbs

carton cube: 24.20 cu.ft.

Packed: 1 item/carton

lounge chair overall: 28" w 33" d 38" h. seat: 22" d 19" h. arm: 25" h.

 double corner blocks: glued & screwed

 high density foam seats: contract quality

so
508

robbie

lounge chair **so50862**

classic design, a very mid-century modern look. enhance your modern home or office with this stylish club-style chair in a walnut finish. This modern chair uses an expertly bench-crafted solid wood frame to support the large high density tufted seat and back. The simplicity flows from front to back and create an artistic contemporary addition to any space.



Cover: Synthetic Leather. Colour: Vintage Brown. Finish: Walnut.

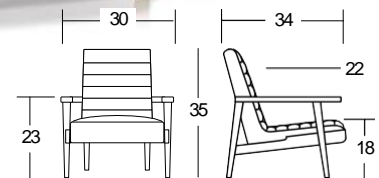

carton size: overall: 32" w 36" d 36" h

carton Weight: 52 lbs

carton cube: 24.0 cu.ft.

Packed: 1 item/carton

lounge chair overall: 30" w 34" d 35" h. seat: 22" d 18" h. arm: 23" h.

 double corner blocks: glued & screwed

 high density foam seats: contract quality

 **so**
664

myriam

lounge chair **so6642**

The 1950s and 1960s were clean, sophisticated, and inclusive. despite the passage of time, mid-century designs have remained a staple in interior architecture. its dual-natured look, minimalistic, edgy, over-stuffed seat and back sits atop a bench-made hardwood frame which is equally sleek and discerning.



*Cover: Tweed.
Colour: Stone.
Finish: Espresso.*

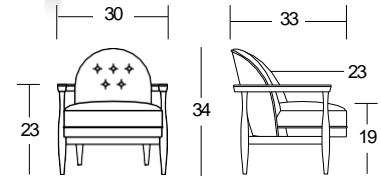

carton size: overall: 29" w 28" d 18" h

carton Weight: 32 lbs

carton cube: 7.77 cu.ft.

Packed: 1 item/carton

lounge chair overall: 30" w 33" d 34" h. seat: 23" d 19" h. arm 23" h

 double corner blocks: glued & screwed

 high density foam seats: contract quality

 **skl**
116

burdette

louis xvi bergère **skl11625**

classic design, a very mid-century modern look. enhance your modern home or office with this stylish arm chair in antique pewter finish. This modern chair uses an expertly bench-crafted solid wood frame to support the large high density tufted seat and back. The simplicity flows from front to back and create an artistic contemporary addition to any space.



*Cover: Baso.
Colour: Stone.
Finish: Antique
Pewter.*

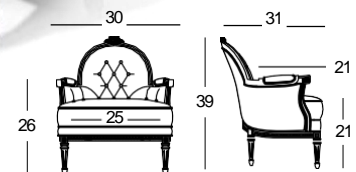

carton size: overall: 34" w 36" d 33" h

carton Weight: 54 lbs

carton cube: 23.36 cu.ft.

Packed: 1 item/carton

bergère overall: 30" w 31" d 39" h. seat: 21" d 21" h. arm: 26" h

resimercial
Furniture

DESIGN FOR TODAY

 double corner blocks: glued & screwed

 high density foam seats: contract quality

sds
2704

midge

lounge chair **sds270420**

shapely curves, channel grooves, a gentle recline and "just-right" pushed padding invite the lost art of unwinding. a sculptural bench frame sets up a striking profile and assures quality in craftsmanship. charm and romanticism are its core - working in tandem with form and function to create furniture that coordinates and compliments any space.



Cover: *Velour.*
Colour: *Gold.*
Finish: *Walnut.*

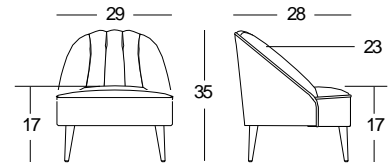

carton size: overall: 30"w 33"d 27"h

carton Weight: 34 lbs

carton cube: 15.47 cu.ft.

Packed: 1 item/carton

lounge chair overall: 29"w 28"d 35"h. seat: 23"d 17"h.

 double corner blocks: glued & screwed

 high density foam seats: contract quality

sds
2702

hanna

lounge chair **sds27027**

comfortable, compact and lightweight, the hanna lounge chair gorgeously unites materials and manufacturing techniques of different eras. The visible connection between the seat and base references joinery used by skilled artisans for centuries. elegant and refined, its wraparound form is an expression of support, offering retreat.



Cover: *Tweed.*
Colour: *Ruby.*
Finish: *Walnut.*

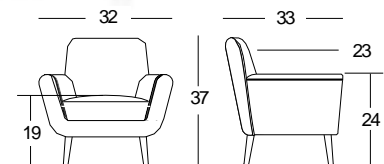

carton size: overall: 34"w 35"d 30"h

carton Weight: 44 lbs

carton cube: 20.66 cu.ft.

Packed: 1 item/carton

lounge chair overall: 32"w 33"d 37"h. seat: 23"d 19"h. arm: 24"h

 double corner blocks: glued & screwed

 high density foam seats: contract quality

aski
101

siegel

tub chair **aski10153**

with its smooth, inviting curves and tailored in a soft durable fabric, this tub chair is dressed for any occasion. The kiln-dried hardwood frame is artisan crafted using the finest techniques and finished with high density foam seat cushions. double corner blocks, glued and screwed for durability.



Cover: Synthetic Leather. Colour: Vintage Caramel. Finish: Espresso.

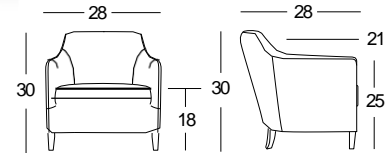

carton size: overall: 32" w 30" d 32" h

carton Weight: 45 lbs

carton cube: 17.78 cu.ft.

Packed: 1 item/carton

tub chair overall: 28" w 28" d 30" h. seat: 21" d 18" h. arm 25" h

 double corner blocks: glued & screwed

 high density foam seats: contract quality

sds
2716

deeny

lounge chair **sds271663**

comfortable, compact and lightweight, the deeny lounge chair gorgeously unites materials and manufacturing techniques of different eras. The visible connection between the seat and base references joinery used by skilled artisans for centuries. elegant and refined, its wraparound form is an expression of support, offering retreat.



Cover: Velour. Colour: Magenta. Finish: Walnut.

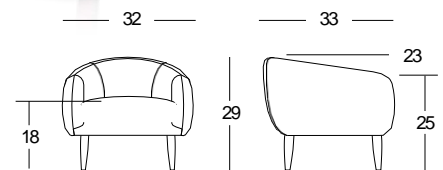

carton size: overall: 32" w 38" d 21" h

carton Weight: 28 lbs

carton cube: 12.83 cu.ft.

Packed: 1 item/carton

lounge chair overall: 32" w 33" d 29" h. seat: 23" d 18" h. arm: 25" h

resimercial
Furniture

DESIGN FOR TODAY

 double corner blocks: glued & screwed

 high density foam seats: contract quality

 **so**
188

wilmar

lounge chair **so1886**

comfortable, compact and lightweight. gorgeously unites materials and manufacturing techniques of different eras. The visible connection between the seat and base references joinery used by skilled artisans for centuries. modern, elegant and refined, its wraparound form is an expression of support, offering retreat.



Cover: Tweed.
Colour: Stone.
Finish: Walnut.

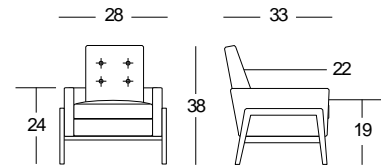

carton size: overall: 30" w 35" d 40" h

carton Weight: 48 lbs

carton cube: 24.31 cu.ft.

Packed: 1 item/carton

lounge chair overall: 28" w 33" d 38" h. seat: 22" d 19" h. arm: 24" h.

 double corner blocks: glued & screwed

 high density foam seats: contract quality

 **sds**
2727

marion

lounge chair **sds272721**

The stunningly chic. This modern tufted buttoned back lounge chair is defined by its oversized seating enhanced with plush cushioning, body-cradling curves, and soft, luxurious upholstery – a complement to any style decor. its turned, flared wooden legs give off an organic vibe while ensuring a sturdy and durable stance.



Cover: Nubia.
Colour: Charcoal.
Finish: Walnut.

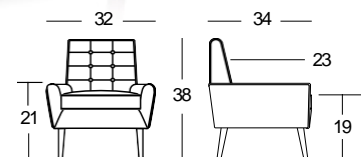

carton size: overall: 33" w 30" d 17" h

carton Weight: 51 lbs

carton cube: 10.50 cu.ft.

Packed: 1 item/carton

lounge chair overall: 32" w 34" d 38" h. seat: 23" d 19" h. arm: 21" h

 double corner blocks: glued & screwed

 high density foam seats: contract quality

 **sgy**
0019

malin

lounge chair **sgy0019**

exceptionally comfortable mid-century modern lounge chair with one-piece seat and back rest. sophistication personified – sleek lines, seductively simple. a great compliment to any livingroom setting or use in pairs to flank the fireplace. kiln dried hardwood frame is double-doweled, glued and screwed for enduring wear.



*Cover: Tweed.
Colour: Orchid.
Finish: Espresso*

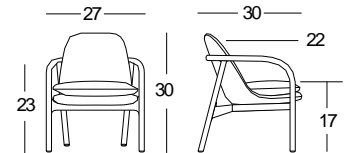

carton size: overall: 30" w 28" d 32" h

carton Weight: 35 lbs

carton cube: 15.56 cu.ft.

Packed: 1 item/carton

lounge chair overall: 27" w 30" d 30" h. seat: 22" d 17" h. arm: 23" h

 double corner blocks: glued & screwed

 high density foam seats: contract quality

 **so**
766

claiborne

lounge chair **so76663**

This generously proportioned transitional lounge chair offers a high winged-back, cupped to cradle your back, while the wide, gently curved seat allows plenty of legroom. Topped by a decadent upholstery. meticulously crafted, the thickly padded frame is accented by a loose kidney pillow.



*Cover: Move.
Colour: Dim Gray.
Finish: Espresso.*

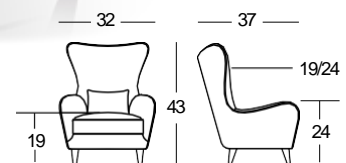

carton size: overall: 33" w 39" d 35" h

carton Weight: 48 lbs

carton cube: 19.42 cu.ft.

Packed: 1 item/carton

lounge chair overall: 32" w 37" d 43" h. seat: 19" d 19" h. arm: 24" h

resimercial
Furniture

DESIGN FOR TODAY

 double corner blocks: glued & screwed

 high density foam seats: contract quality

 **so**
2162

carnell

lounge chair **so216213**

extremely comfortable and luxurious, uniquely modern and gorgeously enhanced by sophisticated retro aesthetics. quirky, hip, this exaggerated lounge chair has a flared, wide back with arms that slope toward the base. Tight seat, high back, sits on tall, tapered legs.



Cover: Cross.
Colour: Flax.
Finish: Espresso.

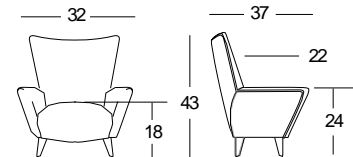

carton size: overall: 33" w 41" d 38" h

carton Weight: 55 lbs

carton cube: 29.75 cu.ft.

Packed: 1 item/carton

lounge chair overall: 32" w 37" d 43" h. seat: 22" d 18" h. arm: 24" h

 double corner blocks: glued & screwed

 high density foam seats: contract quality

 **so**
2162

carnell

lounge chair **so216214**

extremely comfortable and luxurious, uniquely modern and gorgeously enhanced by sophisticated retro aesthetics. quirky, hip, this exaggerated lounge chair has a flared, wide back with arms that slope toward the base. Tight seat, high back, sits on tall, tapered legs.



Cover: Doni.
Colour: Sandstone.
Finish: Espresso.

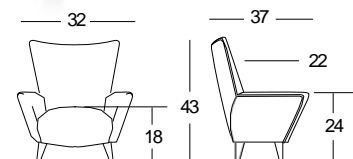

carton size: overall: 33" w 41" d 38" h

carton Weight: 55 lbs

carton cube: 29.75 cu.ft.

Packed: 1 item/carton

lounge chair overall: 32" w 37" d 43" h. seat: 22" d 18" h. arm: 24" h

 double corner blocks: glued & screwed

 high density foam seats: contract quality

ISO
451

cyd

lounge chair **so45103**

curvy, chic and ever fashion forward. double corner blocks, pinched back rest and extra padded seat, wooden seat shell covered with ergonomic high-density foam for a softer impact. perfectly proportioned wood legs. high impact, rock solid design, contract quality. Tasteful, impeccably tailored seat upholstery.



Cover: Synthetic
Leather. Colour: Storm
Gray. Finish: Espresso.

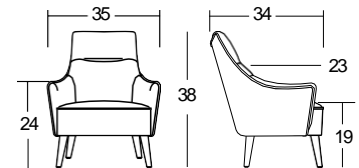

carton size: overall: 34" w 34" d 32" h
carton cube: 21.41 cu.ft.

carton Weight: 48 lbs
Packed: 1 item/carton

lounge chair overall: 35" w 34" d 38" h. seat: 23" d 19" h. arm: 24" h

 double corner blocks: glued & screwed

 high density foam seats: contract quality

ISO
451

cyd

lounge chair **so45140**

curvy, chic and ever fashion forward. double corner blocks, pinched back rest and extra padded seat, wooden seat shell covered with ergonomic high-density foam for a softer impact. perfectly proportioned wood legs. high impact, rock solid design, contract quality. Tasteful, impeccably tailored seat upholstery.



Cover: Woolrich.
Colour: Pebble.
Finish: Espresso.

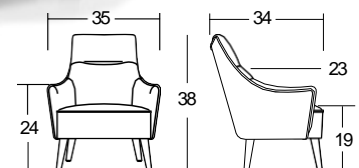

carton size: overall: 34" w 34" d 32" h
carton cube: 21.41 cu.ft.

carton Weight: 48 lbs
Packed: 1 item/carton

lounge chair overall: 35" w 34" d 38" h. seat: 23" d 19" h. arm: 24" h

resimercial
Furniture

DESIGN FOR TODAY

 double corner blocks: glued & screwed

 high density foam seats: contract quality

 **so**
217

claybourne

lounge chair **so2172**

This transitional lounge chair offers a simplified modern feel with an appealing nod to the past. kiln dried hardwood frame is double-doweled, glued and screwed for enduring wear. generously padded frame and deep, high density foam cushion, hand tacked chrome nail heads bring out the best in every line.



*Cover: Doni.
Colour: Sandstone.
Finish: Espresso.
Chrome Nail Heads*

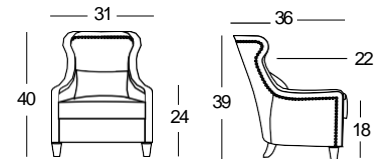

carton size: overall: 32" w 36" d 35" h

carton Weight: 53 lbs

carton cube: 23.33cu.ft.

Packed: 1 item/carton

lounge chair overall: 31" w 36" d 39" h. seat: 22" d 18" h. arm: 24" h

 double corner blocks: glued & screwed

 high density foam seats: contract quality

 **so**
217

claybourne

lounge chair **so2174**

This transitional lounge chair offers a simplified modern feel with an appealing nod to the past. kiln dried hardwood frame is double-doweled, glued and screwed for enduring wear. generously padded frame and deep, high density foam cushion, hand tacked chrome nail heads bring out the best in every line.



*Cover: Tweed.
Colour: Pebble.
Finish: Espresso.*

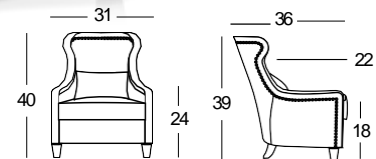

carton size: overall: 32" w 36" d 35" h

carton Weight: 53 lbs

carton cube: 23.33cu.ft.

Packed: 1 item/carton

lounge chair overall: 31" w 36" d 39" h. seat: 22" d 18" h. arm: 24" h

 double corner blocks: glued & screwed

 high density foam seats: contract quality

 **sds**
2701

rooney

lounge chair **sds270169**

This transitional wing back lounge chair offers a slimmed down and simplified modern feel with an appealing nod to the past. kiln dried hardwood frame is double-doweled, glued and screwed for enduring wear. padded frame, high density foam cushion, nestling wings brings out the best in every line.



Cover: Woolrich
Colour: Stone.
Finish: Walnut.

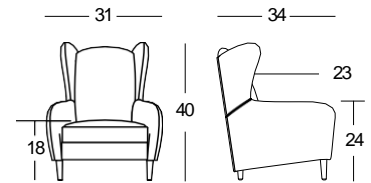

carton size: overall: 32" w 33" d 38" h
carton cube: 23.22 cu.ft.

carton Weight: 59 lbs
Packed: 1 item/carton

lounge chair overall: 31" w 34" d 40" h. seat: 23" d 18" h. arm: 24" h

 double corner blocks: glued & screwed

 high density foam seats: contract quality

 **sup**
746

ponti

roll arM Wing chair **sup7468**

extremely comfortable and luxurious, uniquely modern and gorgeously enhanced by sophisticated retro aesthetics. This exaggerated wing chair has flared arms that slope toward the legs. generously padded frame and deep and high density foam cushion bring out the best in every line.



Cover: Tweed.
Colour: Aqua.
Finish: Espresso.

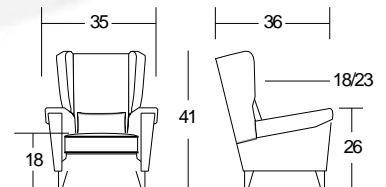

carton size: overall: 36" w 37" d 35" h
carton cube: 26.98 cu.ft.

carton Weight: 51 lbs
Packed: 1 item/carton

wing chair overall: 35" w 36" d 41" h. seat: 18" d 18" h. arm: 26" h



double corner blocks: glued & screwed



high density foam seats: contract quality

sup
601

lyle

lounge chair **sup6019**

This transitional lounge chair offers a simplified modern feel with an appealing nod to the past. Kiln dried hardwood frame is double-doweled, glued and screwed for enduring wear. generously padded frame and deep, high density foam cushion, hand tacked chrome nail heads bring out the best in every line.



*Cover: Woolrich
Colour: Rock.
Finish: Espresso.
Chrome Nail Heads.*

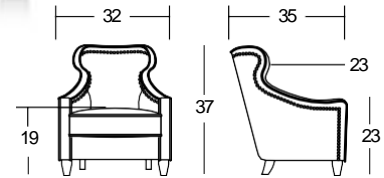

carton size: overall: 34" w 36" d 38" h
carton cube: 23.38 cu.ft.

carton Weight: 54 lbs
Packed: 1 item/carton

lounge chair overall: 32" w 35" d 37" h. seat: 23" d 19" h. arm: 23" h



double corner blocks: glued & screwed



high density foam seats: contract quality

sup
130

paloma

lounge chair **sup1309**

This generously proportioned transitional lounge chair offers a deep buttoned back, cupped to cradle your back, while the wide, gently curved seat allows plenty of legroom. Topped by a decadent upholstery, meticulously crafted, the thickly padded frame is accented by a loose kidney pillow.



*Cover: Weave.
Colour: Lake.
Finish: Espresso.*

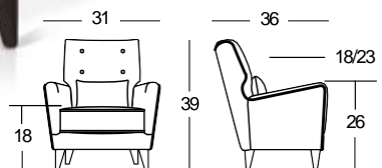

carton size: overall: 34" w 31" d 30" h
carton cube: 20.54 cu.ft.

carton Weight: 64 lbs
Packed: 1 item/carton

lounge chair overall: 31" w 36" d 39" h. seat: 18" d 18" h. arm: 26" h



high density foam seat



full circumference welds: contract quality

sef
3216

leoni

swivel side chair **sef321605**

dine in elegant style and sumptuous comfort with this sleek, sophisticated swivel side chair. luxurious, floating seat that's rests atop a lustrous, quad-pod swivel base for an aesthetic look while ensuring strength and stability. a complement to any modern design and colour scheme.



Cover: Weave.
Colour: Rock.
Finish: Black Powder
Coated Steel.

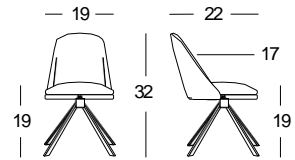

carton size: overall: 29"w 28"d 20"h

carton cube: 7.0cu.ft.

carton Weight: 40 lbs

Packed: 2 items/carton

swivel chair overall: 19"w 22"d 32"h. seat: 17"d 19"h.



high density foam seat



full circumference welds: contract quality

sef
3205

mitchum

side chair **sef320580**

a refined combination of finish and colour. The quality and richness of its component materials, both for the body and the base, make it particularly elegant and sophisticated. elegantly characterized by splayed, chisel-shaped legs with one piece seat and back. pure expression of form and function - realized in its fluid curves and lines. a complement to any modern design.



Cover: Synthetic Leather.
Colour: Dove Gray.
Finish: Black Powder
Coated Steel.

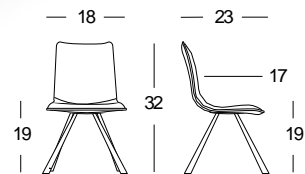

carton size: overall: 25"w 29"d xx19"h

carton cube: 7.97cu.ft.

carton Weight: 36 lbs

Packed: 2 items/carton

side chair overall: 18"w 23"d 32"h. seat: 17"d 19"h.

resimercial
Furniture

DESIGN FOR TODAY

 high density foam seat

 full circumference welds: contract quality

Asha
278

ludwig

swivel lounge chair **sha2782**

if you like modern design interiors, this swivel chair will surely appeal to you. solid steel construction complimented by a comfortable seat covered with faux leather upholstery. The quality and richness of its component materials, both for the body and the base, make it particularly elegant and sophisticated.



*Fabric Cover: Woolrich.
Colour: Rain.
PU Cover: Synthetic
Leather. Colour: Charcoal.
Finish: Black Powder
Coated Steel.*

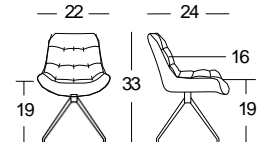

carton size: overall: 30"w 23"d 25"h

carton Weight: 44 lbs

carton cube: 9.98cu.ft.

Packed: 2 items/carton

swivel chair overall: 22"w 24"d 33"h. seat: 16"d 19"h.

 high density foam seat

 full circumference welds: contract quality

sct
319

barton

counter stools

elegant stools characterized by splayed, chisel shaped legs with one piece seat and back. pure expression of form and of function, with the futuristic design - realized in its fluid curves and lines. a complement to any modern design and colour scheme.

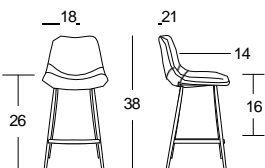

sct31907

*Cover: Tweed. Colour: Heather.
Finish: Brushed Stainless Steel.*

sct31910

*Cover: Synthetic Leather. Colour: Black.
Finish: Black Powder Coated Steel.*

carton size: overall: 19"w 49"d 21"h

carton Weight: 36 lbs

carton cube: 11.31 cu.ft.

Packed: 2 items/carton

counter stool overall: 18"w 21"d 38"h. seat: 14"d. 26"h.



high density foam seat



full circumference welds: contract quality

sef
3183

neo

side chair sef318374

one of the most intriguing things about this side chair is the disparity between its delicate, lightweight appearance and its actual strength, not to mention its remarkable durability. This statuesque chair's thick padded pillow top seat, should not surprise you with its comfort. enjoy the next meal in both comfort and style with the effortlessly impressive neo side chair.



carton size: overall: 24"w 18"d 37"h

carton cube: 9.25cu.ft.

carton Weight: 42 lbs

Packed: 2 items/carton



Cover: Synthetic Leather.
Colour: Black.
Finish: Black Powder
Coated Steel.

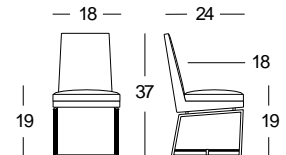

side chair overall: 18"w 24"d 37"h. seat: 18"d 19"h.



high density foam seat



full circumference welds: contract quality

sef
3181

allen

side chair sef3181c

The allen side chair features a refined combination of finish and colour. The quality and richness of its component materials, both for the body and the base, make it particularly elegant and sophisticated. ideal for the home, in dining rooms, but it also fits nicely into offices as a representative chair in the meeting room or in waiting areas.



carton size: overall: 41"w 26"d 22"h

carton cube: 13.75cu.ft.

carton Weight: 33 lbs

Packed: 2 items/carton



Cover: Keystone.
Colour: Charcoal.
Finish: Chrome.

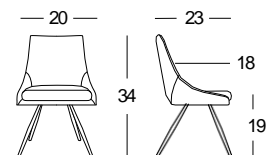

side chair overall: 20"w 23"d 34"h. seat: 18"d 19"h.

resimercial
Furniture

DESIGN FOR TODAY

 high density foam seat

 full circumference welds: contract quality



foster

side chairs

one of the most intriguing things about this side chair is the disparity between its delicate, lightweight appearance and its actual strength and remarkable durability. This side chair will also surprise you with its comfort.

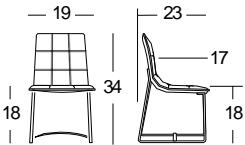

sha500sb
Cover: Synthetic Leather.
Colour: Black. Finish: Chrome.



sha500sw
Cover: Synthetic Leather.
Colour: White. Finish: Chrome.

carton size: overall: 21" w 29" d 25" h

carton Weight: 41 lbs

carton cube: 8.81 cu. ft.

Packed: 2 items/carton

side chair overall: 19" w 23" d 34" h. seat: 17" d 18" h.

 high density foam seat

 full circumference welds: contract quality



foster

side chairs

one of the most intriguing things about this side chair is the disparity between its delicate, lightweight appearance and its actual strength and remarkable durability. This side chair will also surprise you with its comfort.

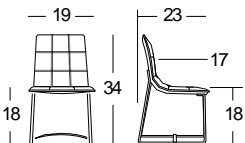

sha500sg
Cover: Synthetic Leather.
Colour: Gray. Finish: Chrome.



sha500ss
Cover: Vision. Colour: Silverfox.
Finish: Chrome.

carton size: overall: 21" w 29" d 25" h

carton Weight: 41 lbs

carton cube: 8.81 cu. ft.

Packed: 2 items/carton

side chair overall: 19" w 23" d 34" h. seat: 17" d 18" h.



high density foam seat



full circumference welds: contract quality

sef
501

jaynice

side chair sha50139

one of the most intriguing things about this side chair is the disparity between its delicate, lightweight appearance and its actual strength and remarkable durability. This side chair will also surprise you with its comfort.



Cover: Cashmere.
Colour: Citrus.
Finish: Chrome.

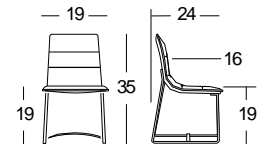

carton size: overall: 21"w 29"d 25"h

carton Weight: 41 lbs

carton cube: 8.81 cu.ft.

Packed: 2 items/carton

side chair overall: 19"w 24"d 35"h. seat: 16"d 19"h.



high density foam seat



full circumference welds: contract quality

sef
501

jaynice

side chairs

one of the most intriguing things about this side chair is the disparity between its delicate, lightweight appearance and its actual strength and remarkable durability. This side chair will also surprise you with its comfort.



sha50117
Cover: Weave. Colour: Rock.
Finish: Chrome.



sha50116
Cover: Weave. Colour: Vellum.
Finish: Chrome.

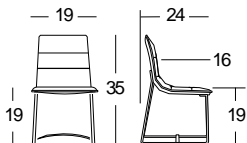

carton size: overall: 21"w 29"d 25"h

carton Weight: 41 lbs

carton cube: 8.81 cu.ft.

Packed: 2 items/carton

side chair overall: 19"w 24"d 35"h. seat: 16"d 19"h.

 high density foam seat

 full circumference welds: contract quality

 **sef**
3226

cetti

counter stool **sef322674**

This counterstool is elegant and comfortable. The lightweight chromed steel frame supports a thick padded synthetic leather seat. This modern counter stool easily fits your decor and features a great modern design that won't go unnoticed. Enjoy the next meal in both comfort and style with the effortlessly impressive ceTTi counter stool.



Cover: Synthetic Leather.
Colour: Black.
Finish: Chrome.

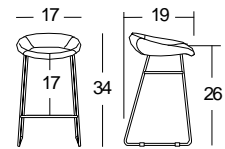

carton size: overall: 18" w 20" d 36" h

carton Weight: 17 lbs

carton cube: 7.40 cu. ft.

Packed: 1 item/carton

counter stool overall: 17" w 19" d 30" h. seat: 14" d 26" h.

 high density foam seat

 full circumference welds: contract quality

 **sct**
203

jullian

counter stool **sct22010c**

This counter stool features a refined combination of finish and colour. The quality and richness of its component materials, both for the body and the base, make it particularly elegant and sophisticated. The disparity between its delicate, lightweight appearance and its actual strength and remarkable durability is most intriguing.



Cover: Synthetic Leather.
Colour: Black.
Finish: Black Powder Coated Steel.

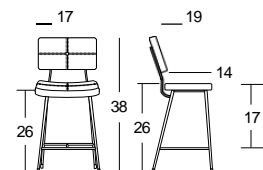

carton size: overall: 24" w 34" d 18" h

carton Weight: 34 lbs

carton cube: 8.50 cu. ft.

Packed: 2 items/carton

counter stool overall: 17" w 19" d 38" h. seat: 14" d. 26" h.

 high density foam seat

 full circumference welds: contract quality

sef
317

corry

side chairs

sleek design meets impressive comfort. This modern chair easily fits your modern decor and features a great modern design that won't go unnoticed. enjoy the next meal in both comfort and style with the effortlessly impressive corry side chairs.

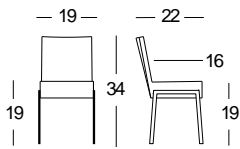

sef317180
Cover: Synthetic Leather.
Colour: Dove Gray. Finish: Chrome.



sef317026
Cover: Synthetic Leather.
Colour: White. Finish: Chrome.

carton size: overall: 26" w 26" d 19" h

carton Weight: 44 lbs

carton cube: 7.43cu.ft.

Packed: 2 items/carton

side chair overall: 19" w 22" d 34" h. seat: 16" d 19" h.

 high density foam seat

 full circumference welds: contract quality

sef
314m

ellen

arm chairs

modernism that is so clean, elegant, warm and inviting, and classically proportioned. The progression of seat-to-backrest is answered by the sturdy curved armrests whose metal contours angle down to cantilevered legs, adding luster and ensures stability.

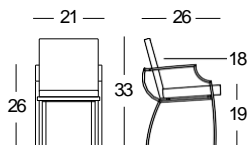

sef314m80
Cover: Synthetic Leather.
Colour: Dove Gray. Finish: Chrome.



sef314m26
Cover: Synthetic Leather.
Colour: White. Finish: Chrome.

carton size: overall: 29" w 25" d 28" h

carton Weight: 24 lbs

carton cube: 11.75cu.ft.

Packed: 2 items/carton

arm chair overall: 21" w 26" d 33" h. seat: 18" d 19" h. arm: 26" h.

 high density foam seat

 full circumference welds: contract quality

sef
3161

olly

side chair **sef316174**

sleek design meets impressive comfort. This modern dining chair easily fits your modern decor and features a great modern design that won't go unnoticed. enjoy the next meal in both comfort and style with the effortlessly impressive olly side chair.



Cover: Synthetic Leather.
Colour: Black.
Finish: Chrome.

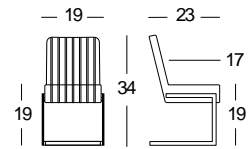

carton size: overall: 23" w 33" d 22" h

carton Weight: 42 lbs

carton cube: 9.66cu.ft.

Packed: 2 items/carton

side chair overall: 19" w 23" d 34" h. seat: 17" d 19" h.

 high density foam seat

 full circumference welds: contract quality

sef
4131

garbo

side chairs

dine in elegant style and sumptuous comfort with this sleek, sophisticated side chair. The luxurious, floating seat rests between a lustrous, sled-inspired base for an aesthetic look. a complement to any modern design and colour scheme.

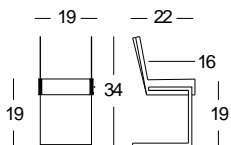

sef413180

Cover: Synthetic Leather.
Colour: Dove Gray. Finish: Chrome.

sef413126

Cover: Synthetic Leather.
Colour: White. Finish: Chrome.

carton size: overall: 23" w 33" d 22" h

carton Weight: 42 lbs

carton cube: 9.66cu.ft.

Packed: 2 items/carton

counter stool overall: 19" w 22" d 34" h. seat: 16" d 19" h.



high density foam seat



full circumference welds: contract quality

sef
3131

abby

side chair **sef313134**

dine in elegant luxurious style and comfort with this sleek, sophisticated side chair. sumptuous , floating seat that rests between a lustrous, sled-inspired brass titanized stainless steel base for an aesthetic look, while ensuring strength and stability. a perfect complement to any modern design and colour scheme.



*Cover: Velour.
Colour: Forest.
Finish: Brass Titanized
Stainless Steel.*

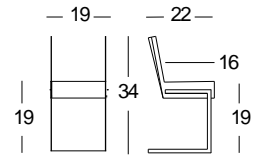

carton size: overall: 23"w 33"d 22"h

carton Weight: 42 lbs

carton cube: 9.66cu.ft.

Packed: 2 items/carton

side chair overall: 19"w 22"d 34"h. seat: 16"d 19"h.



high density foam seat



full circumference welds: contract quality

sef
3131

abby

side chair **sef313116**

dine in elegant luxurious style and comfort with this sleek, sophisticated side chair. sumptuous , floating seat that rests between a lustrous, sled-inspired brass titanized stainless steel base for an aesthetic look, while ensuring strength and stability. a perfect complement to any modern design and colour scheme.



*Cover: Weave.
Colour: Vellum. Finish:
Brass Titanized
Stainless Steel.*

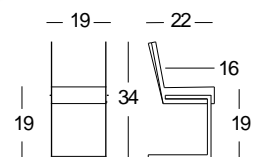

carton size: overall: 23"w 33"d 22"h

carton Weight: 42 lbs

carton cube: 9.66cu.ft.

Packed: 2 items/carton

side chair overall: 19"w 22"d 34"h. seat: 16"d 19"h.

resimercial
Furniture

DESIGN FOR TODAY

 high density foam seat

 full circumference welds: contract quality



abby

side chair **sef313132**

dine in elegant luxurious style and comfort with this sleek, sophisticated side chair. sumptuous , floating seat that rests between a lustrous, sled-inspired electroplated chrome steel base for an aesthetic look, while ensuring strength and stability. a perfect complement to any modern design and colour scheme.



Cover: *Velour.*
Colour: *Dove Gray.*
Finish: *Chrome.*

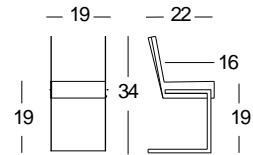

carton size: overall: 23" w 33" d 22" h

carton Weight: 42 lbs

carton cube: 9.66cu.ft.

Packed: 2 items/carton

side chair overall: 19" w 22" d 34" h. seat: 16" d 19" h.

 high density foam seat

 full circumference welds: contract quality



abby

side chair **sef313105**

dine in elegant luxurious style and comfort with this sleek, sophisticated side chair. sumptuous , floating seat that rests between a lustrous, sled-inspired electroplated chrome steel base for an aesthetic look, while ensuring strength and stability. a perfect complement to any modern design and colour scheme.



Cover: *Weave.*
Colour: *Rock.*
Finish: *Chrome.*

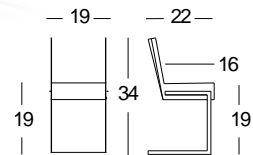

carton size: overall: 23" w 33" d 22" h

carton Weight: 42 lbs

carton cube: 9.66cu.ft.

Packed: 2 items/carton

side chair overall: 19" w 22" d 34" h. seat: 16" d 19" h.



high density foam seat



full circumference welds: contract quality

sef
3131

abby

side chairs

dine in elegant style and sumptuous comfort with this sleek, sophisticated side chair. The luxurious, floating seat rests between a lustrous, sled-inspired base for an aesthetic look. a complement to any modern design and colour scheme.



sef313180

Cover: Synthetic Leather.
Colour: Dove Gray. Finish: Chrome.

sef313126

Cover: Synthetic Leather.
Colour: White. Finish: Chrome.

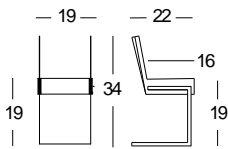

carton size: overall: 23"w 33"d 22"h

carton Weight: 42 lbs

carton cube: 9.66cu.ft.

Packed: 2 items/carton

side chair overall: 19"w 22"d 34"h. seat: 16"d 19"h.



high density foam seat



full circumference welds: contract quality

sef
3131

abby

side chair sef313174

dine in elegant style and sumptuous comfort with this sleek, sophisticated side chair. The luxurious, floating seat rests between a lustrous, sled-inspired base for an aesthetic look. a complement to any modern design and colour scheme.



Cover: Synthetic Leather.
Colour: Black.
Finish: Chrome.

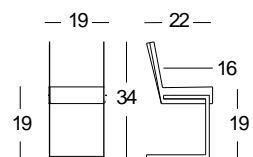

carton size: overall: 23"w 33"d 22"h

carton Weight: 42 lbs

carton cube: 9.66cu.ft.

Packed: 2 items/carton

side chair overall: 19"w 22"d 34"h. seat: 16"d 19"h.

 high density foam seat

 full circumference welds: contract quality

sef
3131

abby

counter stool **sef31318oc**

dine in elegant style and sumptuous comfort with this sleek, sophisticated counter stool. The luxurious, floating seat rests between a lustrous, sled-inspired base for an aesthetic look. a complement to any modern design and colour scheme.



Cover: Synthetic Leather.
Colour: Dove Gray.
Finish: Chrome.

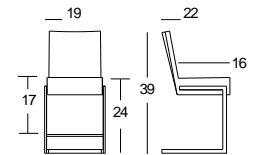

carton size: overall: 38" w 22" d 21" h

carton Weight: 54 lbs

carton cube: 10.16cu.ft.

Packed: 2 items/carton

counter stool overall: 19" w 22" d 39" h. seat: 16" d 24" h.

 high density foam seat

 full circumference welds: contract quality

sef
3131

abby

counter stools

dine in elegant style and sumptuous comfort with this sleek, sophisticated counter stool. The luxurious, floating seat rests between a lustrous, sled-inspired base for an aesthetic look. a complement to any modern design and colour scheme.



sef313174c
Cover: Synthetic Leather.
Colour: Black. Finish: Chrome.

sef313126c
Cover: Synthetic Leather.
Colour: White. Finish: Chrome.

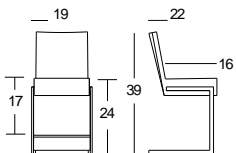

carton size: overall: 38" w 22" d 21" h

carton Weight: 54 lbs

carton cube: 10.16cu.ft.

Packed: 2 items/carton

counter stool overall: 19" w 22" d 39" h. seat: 16" d 24" h.



high density foam seat



full circumference welds: contract quality

sef
3131

abby

bar stool **sef31318ob**

dine in elegant style and sumptuous comfort with this sleek, sophisticated bar stool. The luxurious, floating seat rests between a lustrous, sled-inspired base for an aesthetic look. a complement to any modern design and colour scheme.



Cover: *Synthetic Leather.*
Colour: *Dove Gray.*
Finish: *Chrome.*

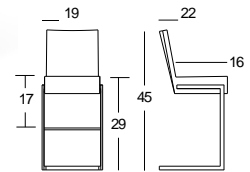

carton size: overall: 27"w 30"d 22"h

carton Weight: 56 lbs

carton cube: 10.31 cu.ft.

Packed: 2 items/carton

bar stool overall: 19"w 22"d 45"h. seat: 16"d 29"h.



high density foam seat



full circumference welds: contract quality

sef
3131

abby

bar stools

dine in elegant style and sumptuous comfort with this sleek, sophisticated bar stool. The luxurious, floating seat rests between a lustrous, sled-inspired base for an aesthetic look. a complement to any modern design and colour scheme.



sef313174b

Cover: *Synthetic Leather.*
Colour: *Black.* Finish: *Chrome.*

sef313126b

Cover: *Synthetic Leather.*
Colour: *White.* Finish: *Chrome.*

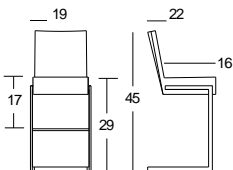

carton size: overall: 27"w 30"d 22"h

carton Weight: 56 lbs

carton cube: 10.31 cu.ft.

Packed: 2 items/carton

bar stool overall: 19"w 22"d 45"h. seat: 16"d 29"h.

 high density foam seat

 full circumference welds: contract quality

sef
3141

max

side chair **sef314180**

sleek design meets impressive comfort. This modern chair easily fits your decor and features a great stylish design that won't go unnoticed. enjoy the next meal in both comfort and style with the effortlessly impressive max side chair.



Cover: Synthetic Leather.
Colour: Dove Gray.
Finish: Chrome.

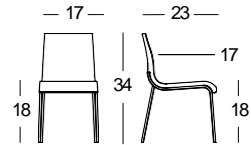

carton size: overall: 32"w 26"d 19"h

carton Weight: 32 lbs

carton cube: 9.20cu.ft.

Packed: 2 items/carton

side chair overall: 17"w 23"d 34"h. seat: 17"d 18"h.

 high density foam seat

 full circumference welds: contract quality

sef
3141

max

side chairs

sleek design meets impressive comfort. This modern chair easily fits your decor and features a great stylish design that won't go unnoticed. enjoy the next meal in both comfort and style with the effortlessly impressive max side chair.



sef314126

Cover: Synthetic Leather.
Colour: White. Finish: Chrome.

sef314174

Cover: Synthetic Leather.
Colour: Black. Finish: Chrome.

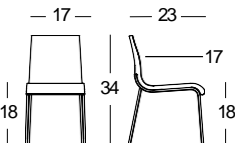
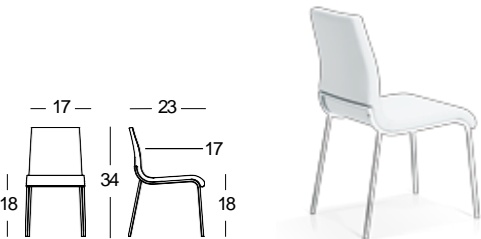

carton size: overall: 32"w 26"d 19"h

carton Weight: 32 lbs

carton cube: 9.20cu.ft.

Packed: 2 items/carton

side chair overall: 17"w 23"d 34"h. seat: 17"d 18"h.



high density foam seat



full circumference welds: contract quality

sef
3141

max

counter stool **sef314180c**

delightfully enjoyable and relaxing, contemporary dinner parties are only a seat away. crafted from a sturdy steel frame, its seat and backrest is upholstered in 3 faux leather options. its elegantly shaped back has an air of royalty and will last for years to come.



Cover: Synthetic Leather.
Colour: Dove Gray.
Finish: Chrome.

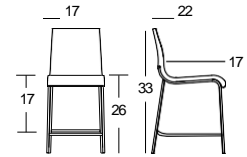

carton size: overall: 35" w 24" d 18" h

carton Weight: 29 lbs

carton cube: 8.75cu.ft.

Packed: 2 items/carton

counter stool overall: 17" w 22" d 33" h. seat: 17" d 26" h.



high density foam seat



full circumference welds: contract quality

sef
3141

max

counter stools

delightfully enjoyable and relaxing, contemporary dinner parties are only a seat away. crafted from a sturdy steel frame, its seat and backrest is upholstered in 3 faux leather options. its elegantly shaped back has an air of royalty and will last for years to come.



sef314126c

Cover: Synthetic Leather.
Colour: White. Finish: Chrome.



sef314174c

Cover: Synthetic Leather.
Colour: Black. Finish: Chrome.

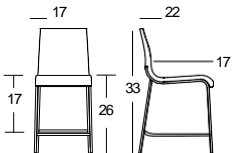

carton size: overall: 35" w 24" d 18" h

carton Weight: 29 lbs

carton cube: 8.75cu.ft.

Packed: 2 items/carton

counter stool overall: 17" w 22" d 33" h. seat: 17" d 26" h.

 high density foam seat

 full circumference welds: contract quality

sef
3141

max

bar stool **sef314180b**

sleek design meets impressive comfort. This modern bar stool easily fits your modern decor and features a great modern design that won't go unnoticed. enjoy the next meal in both comfort and style with the effortlessly impressive max bar stool.



Cover: Synthetic Leather.
Colour: Dove Gray.
Finish: Chrome.

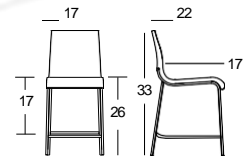

carton size: overall: 41" w 24" d 18" h

carton Weight: 33 lbs

carton cube: 10.25cu.ft.

Packed: 2 items/carton

bar stool overall: 17" w 22" d 37" h. seat: 17" d 30" h.

 high density foam seat

 full circumference welds: contract quality

sef
3141

max

bar stools

sleek design meets impressive comfort. This modern bar stool easily fits your modern decor and features a great modern design that won't go unnoticed. enjoy the next meal in both comfort and style with the effortlessly impressive max bar stool.

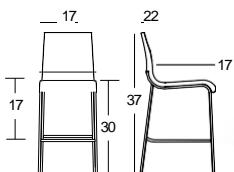

sef314126b

Cover: Synthetic Leather.
Colour: White. Finish: Chrome.

sef314174b

Cover: Synthetic Leather.
Colour: Black. Finish: Chrome.

carton size: overall: 41" w 24" d 18" h

carton Weight: 33 lbs

carton cube: 10.25cu.ft.

Packed: 2 items/carton

bar stool overall: 17" w 22" d 37" h. seat: 17" d 30" h.



KORSON UPHOLSTERY

KORSON'S upholstery collection offers a stunning, yet practical line of fabrics and synthetic leathers to suit multiple applications, and are available in a host of textures, patterns and colours that will complement the way you live. These upholstery covers look amazing, feel wonderful and easily stand up to the rough-and-tumble of regular family life. Suitable for contract and residential environs.



high density foam seat



full circumference welds: contract quality

sct
687

jina counter stool sct687

This counter stool is elegant as it is comfortable. The lightweight brushed stainless steel frame supports a thick padded seat and cushion. Fits easily in your modern decor and features a great modern design that won't go unnoticed. Enjoy the next meal in both comfort and style with the effortlessly impressive jina counter stool.



Cover: Tweed.
Colour: Heather.
Finish: Brushed
Stainless Steel.

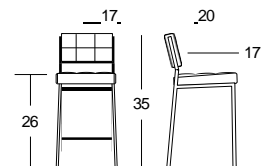

carton size: overall: 24" w 38" d 18" h

carton Weight: 34 lbs

carton cube: 9.50 cu. ft.

Packed: 2 items/carton

counter stool overall: 17" w 20" d 35" h. seat: 17" d 26" h.

resimercial
Furniture

DESIGN FOR TODAY

 high density foam seat

 full circumference welds: contract quality

Asha
803

ian

side chair **sha803b**

simple yet elegant and unmistakably comfortable, this chair will enrich any modern dining room with its exquisite, contemporary style and luxurious design. featuring a sturdy metal frame, padded seat and back – soft, luxurious faux leather upholstery for exceeding comfort and support.



Cover: Synthetic Leather.
Colour: Black.
Finish: Chrome.

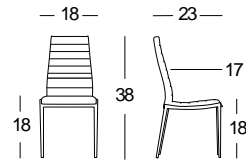

carton size: overall: 33"w 22"d 20"h

carton Weight: 32 lbs

carton cube: 8.40cu.ft.

Packed: 2 items/carton

side chair overall: 18"w 23"d 38"h. seat: 17"d 18"h.

 high density foam seat

 full circumference welds: contract quality

Asha
371

linus

stacking side chair **sha3817**

The linus side chair features a refined combination of finish and colour. The quality and richness of its component materials, both for the body and the base, make it particularly elegant and sophisticated. ideal for the home, in dining rooms, but it also fits nicely into offices as a representative chair in the meeting room or in waiting areas.



Cover: Weave.
Colour: Rock.
Finish: Chrome.

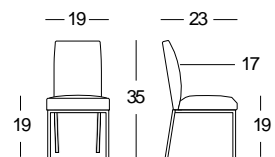

carton size: overall: 23"w 19"d 35"h

carton Weight: 35 lbs

carton cube: 8.85cu.ft.

Packed: 2 items/carton

side chair overall: 19"w 23"d 35"h. seat: 17"d 19"h.



high density foam seat



full circumference welds: contract quality

shbz
101

monaco

side chair **shbz101dg**

delightfully enjoyable and relaxing, contemporary dinner parties are only a seat away. crafted from a sturdy steel frame, its seat and backrest is upholstered in 3 faux leather options. its elegantly shaped back has an air of royalty and will last for years to come.



Cover: Synthetic Leather.
Colour: Dove Gray.
Finish: Chrome.

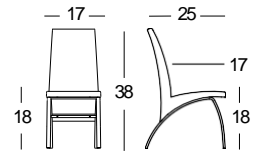

carton size: overall: 29"w 33"d 19"h

carton cube: 10.52cu.ft.

carton Weight: 43 lbs

Packed: 2 items/carton

side chair overall: 17"w 25"d 38"h. seat: 17"d 18"h.



high density foam seat



full circumference welds: contract quality

shbz
314m

monaco

side chairs

delightfully enjoyable and relaxing, contemporary dinner parties are only a seat away. crafted from a sturdy steel frame, its seat and backrest is upholstered in 3 faux leather options. its elegantly shaped back has an air of royalty and will last for years to come.



shbz101b

Cover: Synthetic Leather.
Colour: Black. Finish: Chrome.



shbz101w

Cover: Synthetic Leather.
Colour: White. Finish: Chrome.

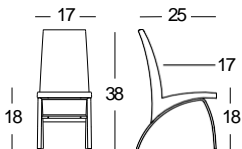

carton size: overall: 29"w 33"d 19"h

carton cube: 10.52cu.ft.

carton Weight: 43 lbs

Packed: 2 items/carton

side chair overall: 17"w 25"d 38"h. seat: 17"d 18"h.

 high density foam seat

 full circumference welds: contract quality

hsef
3161

alia

stacking side chair **sha1416**

sleek design meets impressive comfort. This modern side chair easily fits your modern decor and features a great modern design that won't go unnoticed. enjoy the next meal in both comfort and style with the effortlessly impressive alia side chair.



Cover: Weave.
Colour: Vellum.
Finish: Brushed
Stainless Steel.

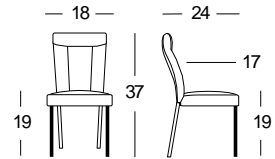

carton size: overall: 27" w 20" d 42" h
carton cube: 13.13 cu. ft.

carton Weight: 28 lbs
Packed: 2 items/carton

side chair overall: 18" w 24" d 37" h. seat: 17" d 19" h.

 high density foam seat

 full circumference welds: contract quality

sct
203

j e m

counter stool **sct2067**

This counter stool is elegant as it is comfortable. The lightweight brushed stainless steel frame supports a thick padded seat and cushion. fits easily in your modern decor and features a great modern design that won't go unnoticed. enjoy the next meal in both comfort and style with the effortlessly impressive jem counter stool.



Cover: Tweed.
Colour: Heather.
Finish: Brushed
Stainless Steel.

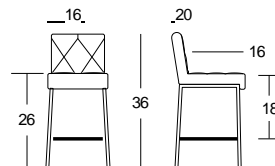

carton size: overall: 24" w 34" d 18" h
carton cube: 8.50 cu. ft.

carton Weight: 34 lbs
Packed: 2 items/carton

counter stool overall: 16" w 20" d 36" h. seat: 16" d. 26" h.



high density foam seat



full circumference welds: contract quality

sct
208

glenda

counter stool **sct20811**

This counter stool is elegant as it is comfortable. The lightweight brushed stainless steel frame supports a thick padded seat and cushion. fits easily in your modern decor and features a great modern design that won't go unnoticed. enjoy the next meal in both comfort and style with the effortlessly impressive glenda counter stool.



carton size: overall: 21"w 48"d 18"h

carton cube: 10.50cu.ft.

carton Weight: 37 lbs

Packed: 2 items/carton



*Cover: Synthetic Leather.
Colour: White.
Finish: Brushed
Stainless Steel.*

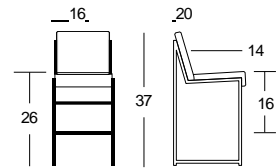

counter stool overall: 16"w 20"d 37"h. seat: 14"d. 26"h.



high density foam seat



full circumference welds: contract quality

sct
203

hyatt

counter stool **sct20313**

This counter stool is elegant as it is comfortable. The lightweight brushed stainless steel frame supports a thick padded seat and cushion. fits easily in your modern decor and features a great modern design that won't go unnoticed. enjoy the next meal in both comfort and style with the effortlessly impressive hyatt counter stool.



carton size: overall: 26"w 24"d 19"h

carton cube: 6.68cu.ft.

carton Weight: 34 lbs

Packed: 2 items/carton



*Cover: Synthetic Leather.
Colour: Taupe.
Finish: Brushed
Stainless Steel.*

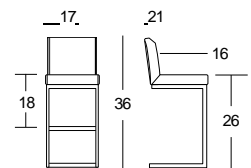

counter stool overall: 17"w 21"d 36"h. seat: 16"d. 26"h.

resimercial
Furniture

DESIGN FOR TODAY

 high density foam seat

 full circumference welds: contract quality



backless

counter stools

simple yet elegant and unmistakably comfortable, this chair will enrich any modern dining room with its exquisite, contemporary style and luxurious design. featuring a sturdy metal frame, padded seat and back – soft, luxurious faux leather upholstery for exceeding comfort and support.



featuring a sturdy metal frame, padded seat and back – soft, luxurious faux leather upholstery for exceeding

loy

counter stool
sct4310

Cover: Synthetic Leather.
Colour: Black. Finish:
Brushed Stainless Steel.

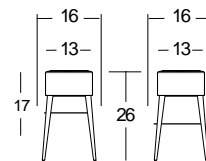

counter stool
overall: 16"w 16"d 26"h. seat: 26"h.

carton size: overall: 16"w 38"d 17"h
carton cube: 5.98cu.ft.

carton Weight: 25 lbs
Packed: 2 items/carton

 high density foam seat

 full circumference welds: contract quality

kipp

swivel counter
stool sct047

Cover: Synthetic Leather.
Colour: Black. Finish:
Brushed Stainless Steel.

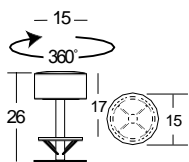

counter stool
overall: 15"w 15"d 26"h. seat: 26"h.

carton size: overall: 24"w 17"d 17"h
carton cube: 4.01cu.ft.

carton Weight: 28 lbs
Packed: 1 item/carton

gates

counter stool
sct1610

Cover: Synthetic Leather.
Colour: Black. Finish:
Brushed Stainless Steel.

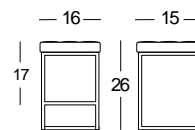

counter stool
overall: 16"w 15"d 26"h. seat: 26"h.

carton size: overall: 18"w 23"d 18"h
carton cube: 4.31cu.ft.

carton Weight: 14 lbs
Packed: 1 item/carton

 double corner blocks: glued & screwed

 high density foam seats: contract quality

Asky
112

heather

side chair **sky112617**

This is a crisply edited side chair with neoclassical roots. a lovely sloping back with gracefully curved exposed top - perfectly complimented by an impeccably tailored upholstery. The heather side chair thrives in both traditional and more contemporary settings. it's commodious yet not overstated.



Cover: Keystone.
Colour: Pebble.
Finish: Walnut.

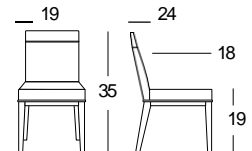

carton size: overall: 21"w 31"d 41"h

carton Weight: 20 lbs

carton cube: 15.45cu.ft.

Packed: 2 items/carton

side chair overall: 19"w 24"d 35"h. seat: 18"d 19"h.

 double corner blocks: glued & screwed

 high density foam seats: contract quality

Asky
1305

kerry

side chairs

sculpted for comfort and styled contemporary, this upholstered accent chair puts everyone at ease. its simplistic look and feel is both luxurious and inviting as a dining chair, or simply as an accent chair use in virtually any room of the home for a striking, modern look.



sky13056

Cover: Tweed. Colour: Sandstone.
Finish: Walnut with Brass Tips.



sky13057

Cover: Synthetic Leather. Colour: Vintage Gray.
Finish: Espresso with Brass Tips.

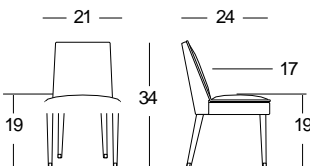

carton size: overall: 33"w 21"d 39"h

carton Weight: 22 lbs

carton cube: 15.64cu.ft.

Packed: 2 items/carton

side chair overall: 21"w 24"d 34"h. seat: 17"d 19"h.

 double corner blocks: glued & screwed

 high density foam seats: contract quality

Asky
109

lauren

side chairs

one thing's for sure. with its innovative lines and careful attention to the tiniest details, this chair is a real show-stopper. and even though it is lovely to look at, it is also extremely comfortable. perfectly proportioned. high impact, rock solid design, contract quality. Tasteful, impeccably tailored fabric seat upholstery.

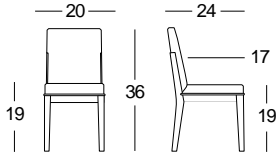

sky109617
Cover: Keystone. Colour: Pebble.
Finish: Walnut.

sky109536
Cover: Pavillion. Colour: Flax.
Finish: Walnut.

carton size: overall: 22"w 35"d 42"h
carton cube: 18.72cu.ft.

carton Weight: 33 lbs
Packed: 2 items/carton

side chair overall: 20"w 24"d 36"h. seat: 17"d 19"h.

 double corner blocks: glued & screwed

 high density foam seats: contract quality

Asky
1305

lauren

swivel counter stool **sky135915**

This swivel counter stool features a refined combination of geometry, finish and colour. The quality and richness of its component materials, both for the body and the base, make it particularly elegant and sophisticated.



Cover: Synthetic Leather.
Colour: Graystone.
Finish: Walnut.

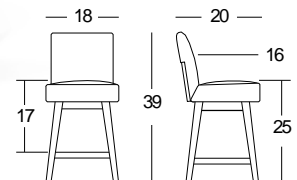

carton size: overall: 20"w 22"d 41"h
carton cube: 10.44cu.ft.

carton Weight: 33 lbs
Packed: 2 items/carton

counter stool overall: 18"w 20"d 39"h. seat: 16"d 25"h.

 double corner blocks: glued & screwed

 high density foam seats: contract quality

 **spd**
302

libby

side chair **spd30233**

This chair features a refined combination of geometry, finish and colour. The quality and richness of its component materials, both for the body and the base, make it particularly elegant and sophisticated.



Cover: Keystone.
Colour: Charcoal.
Finish: Walnut.

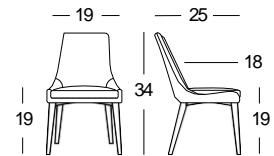

carton size: overall: 25" w 19" d 34" h

carton Weight: 30 lbs

carton cube: 9.35cu.ft.

Packed: 4 items/carton

side chair overall: 19" w 25" d 34" h. seat: 18" d 19" h.

 double corner blocks: glued & screwed

 high density foam seats: contract quality

 **sky**
1382

phoenix

side chair **sky138242**

This is a crisply edited side chair with neoclassical roots. a lovely sloping back with gracefully curved rolled top - perfectly complimented by an impeccably tailored upholstery. The phoenix side chair thrives in traditional and more contemporary settings. it's commodious yet not overstated. hardwood frame bench frame with tapered legs.



Cover: Woolrich.
Colour: Pebble.
Finish: Walnut.

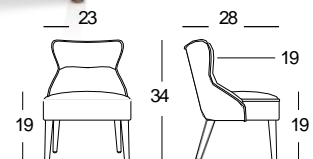

carton size: overall: 24" w 29" d 25" h

carton Weight: 31 lbs

carton cube: 10.07cu.ft.

Packed: 2 items/carton

side chair overall: 23" w 28" d 34" h. seat: 19" d 19" h.

 double corner blocks: glued & screwed

 high density foam seats: contract quality

sky
126

eastwick

side chairs

The simplistic look and feel of this side chair is both luxurious and inviting as a dining chair, and arm chair, or an accent chair use in virtually any room of the modern home for a striking, modern look.



sky12986e

Cover: Tweed. Colour: Sandstone.
Finish: Espresso.

sky12986w

Cover: Tweed. Colour: Sandstone.
Finish: Walnut.

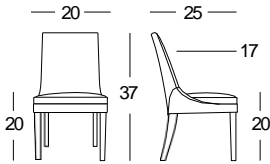

carton size: overall: 22" w 34" d 41" h

carton cube: 17.75 cu. ft.

carton Weight: 20 lbs

Packed: 2 items/carton

side chair overall: 20" w 25" d 37" h. seat: 17" d 20" h.

 double corner blocks: glued & screwed

 high density foam seats: contract quality

sef
314m

eastwick

swivel counter stool **sky15186w**

This swivel counter stool features a refined combination of geometry, finish and colour. The quality and richness of its component materials, both for the body and the base, make it particularly elegant and sophisticated.



Cover: Tweed.
Colour: Sandstone.
Finish: Walnut.

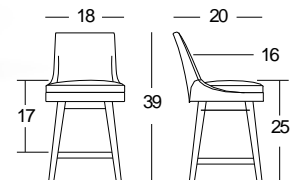

carton size: overall: 19" w 23" d 41" h

carton cube: 10.37 cu. ft.

carton Weight: 24 lbs

Packed: 1 item/carton

counter stool overall: 18" w 20" d 39" h. seat: 16" d 25" h.

resimercial
Furniture

DESIGN FOR TODAY

 double corner blocks: glued & screwed

 high density foam seats: contract quality

 **sup**
1693

eckhart

side chair **sup1693**

slim and tapered legs are crafted in sturdy, solid wood, for comfort and stability. its upholstered back is gently angled and connected to its base for a stylish look, while its thick padded seat supports your body when enjoying those tall cocktails you know you love.



Cover: Doni.
Colour: Sandstone.
Finish: Espresso.

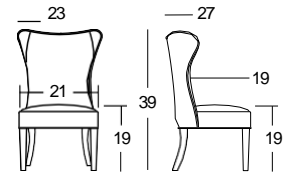

carton size: overall: 23"w 35"d 42"h

carton Weight: 53 lbs

carton cube: 19.57 cu.ft.

Packed: 2 items/carton

side chair overall: 23"w 27"d 39"h. seat: 21"w 19"d 19"h.

 double corner blocks: glued & screwed

 high density foam seats: contract quality

 **sup**
1683

daphne

side chair **sup1683**

slim and tapered legs are crafted in sturdy, solid wood, with padded seat and back for comfort. its low-back upholstery gently slopes and connected to its base for a stylish look, while its thick padded seat supports your body when enjoying those tall cocktails you know you love.



Cover: Doni.
Colour: Sandstone.
Finish: Espresso.

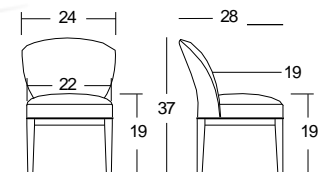

carton size: overall: 24"w 36"d 42"h

carton Weight: 53 lbs

carton cube: 21.00 cu.ft.

Packed: 2 items/carton

side chair overall: 24"w 28"d 37"h. seat: 22"w 19"d 19"h.

 double corner blocks: glued & screwed

 high density foam seats: contract quality

 **so**
2063

larson

side chair **so206340**

This is a crisply edited side chair with neoclassical roots. a lovely sloping back with gracefully curved rolled top - perfectly complimented by an impeccably tailored upholstery. The Larson side chair thrives in traditional and more contemporary settings. it's commodious yet not overstated. hardwood frame is bench made using the finest woodworking techniques.



Cover: Woolrich.
Colour: Pebble.
Finish: Espresso.

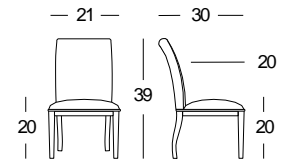

carton size: overall: 22"w 38"d 40"h

carton Weight: 30 lbs

carton cube: 23.71 cu.ft.

Packed: 2 items/carton

side chair overall: 21"w 30"d 39"h. seat: 20"d 20"h.

 double corner blocks: glued & screwed

 high density foam seats: contract quality

 **sky**
1272

vinton

tufted side chairs

This chair features a refined combination of geometry, finish and colour. The quality and richness of its component materials, both for the body and the base, make it particularly elegant and sophisticated.



sky127242

Cover: Woolrich Colour: Pebble.
Finish: Espresso.



sky127243

Cover: Woolrich Colour: Cloud.
Finish: Espresso.

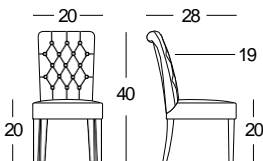

carton size: overall: 21"w 29"d 42"h

carton Weight: 20 lbs

carton cube: 14.80 cu.ft.

Packed: 2 items/carton

side chair overall: 20"w 28"d 40"h. seat: 19"d 20"h.

 double corner blocks: glued & screwed

 high density foam seats: contract quality

Asky
1516

brixton

side chair **sky151615**

slim and tapered legs are crafted in sturdy, solid wood, for comfort and stability. its upholstered back is gently angled and connected to its base for a stylish look, while its thick padded seat supports your body when enjoying those tall cocktails you know you love.



Cover: Strands.
Colour: Oat.
Finish: Espresso.

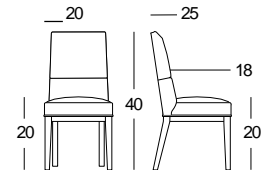

carton size: overall: 21" w 34" d 42" h

carton Weight: 18 lbs

carton cube: 17.35cu.ft.

Packed: 2 items/carton

side chair overall: 20" w 25" d 40" h. seat: 18" d 20" h.

 double corner blocks: glued & screwed

 high density foam seats: contract quality

Asky
1221

lucas

side chairs

slim and tapered legs are crafted in sturdy, solid wood, with padded seat and back for comfort. its low-back upholstery gently slopes and connected to its base for a stylish look, while its thick padded seat supports your body when enjoying those tall cocktails you know you love.



sky122127

Cover: Velour. Colour: Pebble.
Finish: Walnut.

sky122151

Cover: Plush. Colour: Stone.
Finish: Espresso.

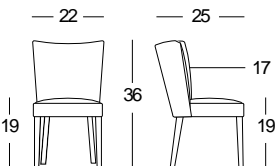

carton size: overall: 23" w 26" d 37" h

carton Weight: 17 lbs

carton cube: 12.80cu.ft.

Packed: 2 items/carton

side chair overall: 22" w 25" d 36" h. seat: 17" d 19" h.

 double corner blocks: glued & screwed

 high density foam seats: contract quality

stb
1052

nellie

side chair **stb1052**

luxurious design meets modern style. kiln-dried solid wood frame will give maximum durability for all of the entertaining that you are going to do with your new chairs. comfort and beauty merge in this fine dining room chair.



Cover: Move.
Colour: Stone.
Finish: Espresso.

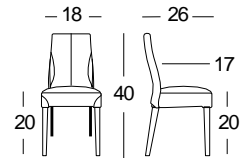

carton size: overall: 18"w 34"d 41"h

carton Weight: 30 lbs

carton cube: 14.52cu.ft.

Packed: 2 items/carton

side chair overall: 18"w 26"d 40"h. seat: 17"d 20"h.

 double corner blocks: glued & screwed

 high density foam seats: contract quality

sky
1281

barrett

Parson chairs

boasting a contemporary profile with luxurious comfort, this side chair is perfect for your formal, modern dining space. a rich upholstery covers the seat and high backrest for smooth, relaxing comfort. The gently rolled top and thick slightly flared legs complete the sleek look, perfect for pairing with a contemporary dining table.



sky128141

Cover: Woolrich Colour: Storm.
Finish: Espresso.

sky128142

Cover: Woolrich Colour: Pebble.
Finish: Espresso.

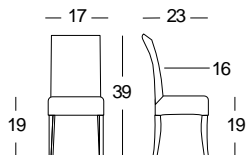

carton size: overall: 18"w 31"d 41"h

carton Weight: 21 lbs

carton cube: 14.80cu.ft.

Packed: 2 items/carton

parson chair overall: 17"w 23"d 39"h. seat: 16"d 19"h.

resimercial
Furniture

DESIGN FOR TODAY

 double corner blocks: glued & screwed

 high density foam seats: contract quality

Asky
1516

howey

Parson chair **sky13136**

while this side chair boasts a sleek silhouette, it also says modern and sophisticated. The thick curved box back and wide, welcoming seat speak fluent comfort. its luxurious extra padded seat encourages lingering over dinner and becomes part of the everyday menu.



Cover: Pavillion.
Colour: Flax.
Finish: Walnut

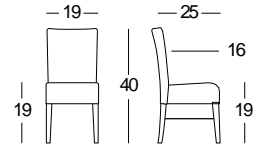

carton size: overall: 20" w 31" d 42" h

carton Weight: 18 lbs

carton cube: 15.07 cu.ft.

Packed: 2 items/carton

parson chair overall: 19" w 25" d 40" h. seat: 16" d 19" h.

 double corner blocks: glued & screwed

 high density foam seats: contract quality

Asky
229

harmony

Parson chair **sky22917**

boasting a contemporary profile with luxurious comfort, this side chair is perfect for your formal, modern dining space. a rich upholstery covers the seat and high backrest for smooth, relaxing comfort. The gently rolled top and thick slightly flared legs complete the sleek look, perfect for pairing with a contemporary dining table.



Cover: Keystone.
Colour: Pebble.
Finish: Espresso.

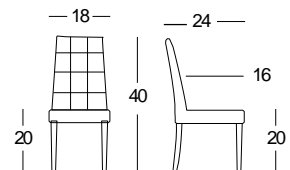

carton size: overall: 18" w 30" d 41" h

carton Weight: 18 lbs

carton cube: 12.81 cu.ft.

Packed: 2 items/carton

parson chair overall: 18" w 24" d 40" h. seat: 16" d 18" h.

 double corner blocks: glued & screwed

 high density foam seats: contract quality

 sky
126

raz

tub chairs

The simplistic look and feel of this tub chair is both luxurious and inviting as a dining chair, and arm chair, or an accent chair use in virtually any room of the modern home for a striking, modern look.



sky12686e
Cover: Tweed. Colour: Sandstone.
Finish: Espresso.



sky12686w
Cover: Tweed. Colour: Sandstone.
Finish: Walnut.

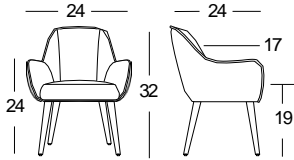

carton size: overall: 24" w 25" d 34" h

carton cube: 11.81 cu. ft.

carton Weight: 29 lbs

Packed: 1 item/carton

tub chair overall: 24" w 24" d 32" h. seat: 17" d 19" h. arm: 24" h

 double corner blocks: glued & screwed

 high density foam seats: contract quality

 sky
553

abelle

tub chair sky55317

The simplistic look and feel of this tub chair is both luxurious and inviting as a dining chair, and arm chair, or an accent chair use in virtually any room of the modern home for a striking, modern look.



Cover: Keystone.
Colour: Pebble.
Finish: Walnut.

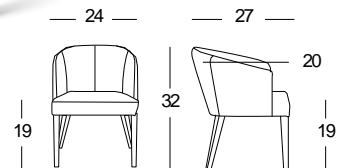

carton size: overall: 25" w 28" d 32" h

carton cube: 12.96 cu. ft.

carton Weight: 29 lbs

Packed: 1 item/carton

tub chair overall: 24" w 27" d 32" h. seat: 20" d 19" h. arm: 27" h

 double corner blocks: glued & screwed

 high density foam seats: contract quality

 **sgb**
875

canalli

slat-back side chair **sgb875**

its low lines breathe glamour into the dining space. from front to back, in profile, every side is its "good side". The comfortable upholstered seat curves down at the front. a sturdy wooden frame with slat-back ensures strength and stability. an optimum balance of lines, curves and elegance.



Cover: Synthetic Leather.
Colour: Brown.
Finish: Walnut.

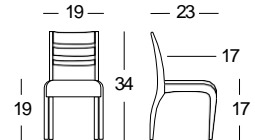

carton size: overall: 20"w 29"d 35"h
carton cube: 11.75cu.ft.

carton Weight: 31 lbs
Packed: 2 items/carton

side chair overall: 19"w 23"d 34"h. seat: 17"d 17"h.

 double corner blocks: glued & screwed

 high density foam seats: contract quality

 **asky**
855

canalli

slat-back side chair **sgb855**

its low lines breathe glamour into the dining space. from front to back, in profile, every side is its "good side". elegant and enduring, this dining chair is ideal for low-key luxury with family or friends. a solid walnut frame and bent veneered-slat is authentic in every detail.



Finish: Walnut.

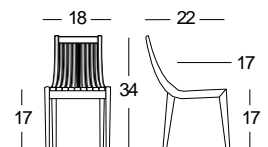

carton size: overall: 20"w 29"d 35"h
carton cube: 11.75cu.ft.

carton Weight: 31 lbs
Packed: 2 items/carton

side chair overall: 18"w 22"d 34"h. seat: 17"d 17"h.

 double corner blocks: glued & screwed

 high density foam seats: contract quality

sky
3605

riley

bar stool **sky360509b**

slim and tapered legs are crafted in sturdy, solid wood, with added footrests for comfort. its short upholstered back is gently angled and connected to its base for a stylish look, while its thick padded seat supports your body when enjoying those tall cocktails you know you love.



carton size: overall: 19"w 23"d 44"h

carton cube: 11.13cu.ft.

carton Weight: 22 lbs

Packed: 1 item/carton



Cover: Bonded Leather.
Colour: Brown.
Finish: Espresso.

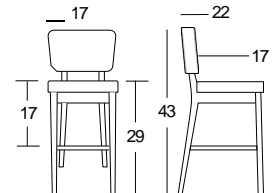

bar stool overall: 17"w 22"d 43"h. seat: 17"d 29"h.

 double corner blocks: glued & screwed

 high density foam seats: contract quality

sds
2705

sherrer

side chair **ski2101**

our elegant, louis xvi chairs offer enduring style that never succumbs to fickle trends. made of solid hardwood; carved to absolute accuracy and sanded to perfection. The frame is assembled with a tongue and groove system and nailed in place by an experienced craftsman.



carton size: overall: 23"w 28"d 35"h

carton cube: 13.04 cu.ft.

carton Weight: 25 lbs

Packed: 1 item/carton



Cover: Synthetic Leather.
Colour: Ice.
Finish: Antique Pewter.

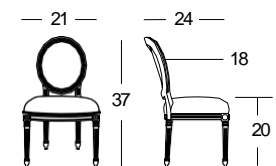

ski2101 overall: 21"w 24"d 37"h. seat: 18"d 20"h.

resimercial
Furniture

DESIGN FOR TODAY

 double corner blocks: glued & screwed

 high density foam seats: contract quality

iso
207

taurus

tufted side chairs

curvy, chic and ever fashion forward. double corner blocks, wooded seat shell covered with ergonomic high-density foam for a softer impact. perfectly proportioned wood legs. high impact, rock solid design, contract quality. Tasteful, impeccably tailored fabric seat upholstery.

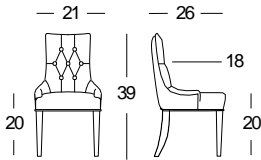

so20740

Cover: Woolrich. Colour: Pebble.
Finish: Espresso.

so20769

Cover: Woolrich. Colour: Stone.
Finish: Espresso. Antique Brass Nail Heads.

carton size: overall: 23" w 32" d 40" h

carton Weight: 44 lbs

carton cube: 17.04 cu. ft.

Packed: 2 items/carton

side chair overall: 21" w 26" d 39" h. seat: 18" d 20" h.

 double corner blocks: glued & screwed

 high density foam seats: contract quality

sgu
804

alexi

side chair **sgu80437**

luxurious design meets modern style. kiln-dried solid wood frame will give maximum durability for all of the entertaining that you are going to do with your new chairs. comfort and beauty merge in this fine dining room chair.



Cover: Hudson.
Colour: Branch.
Finish: Natural.

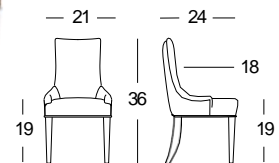

carton size: overall: 22" w 33" d 41" h

carton Weight: 51 lbs

carton cube: 17.23 cu. ft.

Packed: 2 items/carton

side chair overall: 21" w 24" d 36" h. seat: 18" d 19" h.

 double corner blocks: glued & screwed

 high density foam seats: contract quality

skl
800

boris

tufted side chairs

curvy, chic and ever fashion forward. double corner blocks, wooded seat shell covered with ergonomic high-density foam for a softer impact. perfectly proportioned wood legs. high impact, rock solid design, contract quality. Tasteful, impeccably tailored fabric seat upholstery.



skl80137
Cover: Chenille.
Colour: Gray. Finish: Sable.
Chrome Nail Heads.



skl80637
Cover: Synthetic Leather. Colour: Ice.
Finish: Espresso. Chrome Nail Heads,
Crystal Buttons.

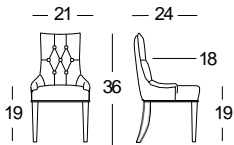

carton size: overall: 22"w 33"d 41"h

carton Weight: 51 lbs

carton cube: 17.23cu.ft.

Packed: 2 items/carton

side chair overall: 21"w 24"d 36"h. seat: 18"d 19"h.

 double corner blocks: glued & screwed

 high density foam seats: contract quality

sup
6619

ryder

tufted side chair **sup6619**

curvy, chic and ever fashion forward. double corner blocks, wooded seat shell covered with ergonomic high-density foam for a softer impact. perfectly proportioned wood legs. high impact, rock solid design, contract quality. Tasteful, impeccably tailored fabric seat upholstery.



Cover: Woolrich.
Colour: Rock.
Finish: Espresso.
Antique Brass
Nail Heads

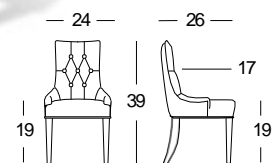

carton size: overall: 23"w 39"d 43"h

carton Weight: 37 lbs

carton cube: 22.32cu.ft.

Packed: 2 items/carton

side chair overall: 24"w 26"d 39"h. seat: 17"d 19"h.

 double corner blocks: glued & screwed

 high density foam seats: contract quality

 sky
1309

britannia

Wing chair **sky130953**

simple yet elegant and unmistakably comfortable, this chair will enrich any modern dining room with its exquisite, contemporary style and luxurious design. featuring a sturdy hardwood frame, padded seat and back – soft, luxurious velour upholstery for exceeding comfort and support.



Cover: *Velour.*
Colour: *Midnight.*
Finish: *Espresso.*
Antique Brass
Nail Heads.

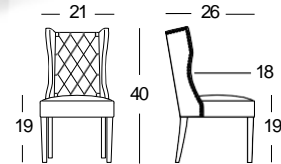

carton size: overall: 22" w 35" d 41" h

carton Weight: 29 lbs

carton cube: 18.27 cu. ft.

Packed: 2 items/carton

wing chair overall: 21" w 26" d 40" h. seat: 18" d 19" h.

 double corner blocks: glued & screwed

 high density foam seats: contract quality

 sky
1309

britannia

Wing chair **sky130978**

simple yet elegant and unmistakably comfortable, this chair will enrich any modern dining room with its exquisite, contemporary style and luxurious design. featuring a sturdy hardwood frame, padded seat and back – soft, luxurious velour upholstery for exceeding comfort and support.



Cover: *Velour.*
Colour: *Pine.*
Finish: *Espresso.*
Antique Brass
Nail Heads

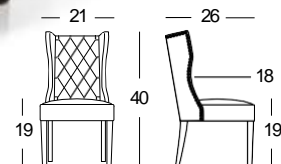

carton size: overall: 22" w 35" d 41" h

carton Weight: 29 lbs

carton cube: 18.27 cu. ft.

Packed: 2 items/carton

wing chair overall: 21" w 26" d 40" h. seat: 18" d 19" h.

 double corner blocks: glued & screwed

 high density foam seats: contract quality

sky
1377

bloomingdale

Wing-back side chair **sky137753**

simple yet elegant and unmistakably comfortable, this chair will enrich any modern dining room with its exquisite, contemporary style and luxurious design. featuring a sturdy hardwood frame, padded seat and back – soft, luxurious velour upholstery for exceeding comfort and support.



Cover: Velour.
Colour: Midnight.
Finish: Espresso with Brass Tips. Antiques Brass Nail Heads

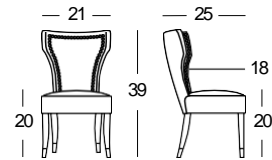

carton size: overall: 22" w 33" d 41" h

carton Weight: 22 lbs

carton cube: 17.23cu.ft.

Packed: 2 items/carton

side chair overall: 21" w 25" d 39" h. seat: 18" d 20" h.

 double corner blocks: glued & screwed

 high density foam seats: contract quality

sky
1377

bloomingdale

Wing-back side chairs

The bloomingdale side chair features a refined combination of finish and colour. The quality and richness of its component materials, both for the body and the base, make it particularly elegant and sophisticated. ideal for the home, in dining rooms, but it also fits nicely into offices as a representative chair in the meeting room or in waiting areas.



sky137727

Cover: Velour. Colour: Pebble.
Finish: Walnut with Brass Tips.
Antique Brass Nail Heads

sky137778

Cover: Velour. Colour: Pine.
Finish: Espresso with Brass Tips.
Antique Brass Nail Heads

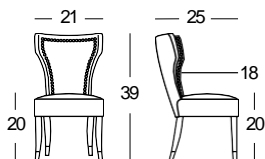

carton size: overall: 22" w 33" d 41" h

carton Weight: 22 lbs

carton cube: 17.23cu.ft.

Packed: 2 items/carton

side chair overall: 21" w 25" d 39" h. seat: 18" d 20" h.

resimercial
Furniture

DESIGN FOR TODAY

 double corner blocks: glued & screwed

 high density foam seats: contract quality



hersey

Wing chair **sky135253**

simple yet elegant and unmistakably comfortable, this chair will enrich any modern dining room with its exquisite, contemporary style and luxurious design. featuring a sturdy hardwood frame, padded seat and back – soft, luxurious velour upholstery for exceeding comfort and support.



Cover: *Velour.*
Colour: *Midnight.*
Finish: *Espresso.*
Brass Nail Heads

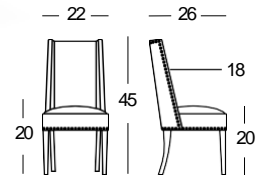

carton size: overall: 23" w 28" d 47" h

carton Weight: 31 lbs

carton cube: 17.52 cu. ft.

Packed: 1 item/carton

wing chair overall: 22" w 26" d 45" h. seat: 18" d 19" h.

 double corner blocks: glued & screwed

 high density foam seats: contract quality



hersey

Wing chair **sky135278**

simple yet elegant and unmistakably comfortable, this chair will enrich any modern dining room with its exquisite, contemporary style and luxurious design. featuring a sturdy hardwood frame, padded seat and back – soft, luxurious velour upholstery for exceeding comfort and support.



Cover: *Velour.*
Colour: *Pine.*
Finish: *Espresso.*
Brass Nail Heads

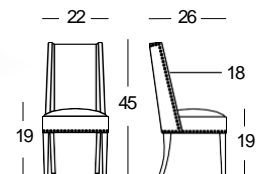

carton size: overall: 23" w 28" d 47" h

carton Weight: 31 lbs

carton cube: 17.52 cu. ft.

Packed: 1 item/carton

wing chair overall: 22" w 26" d 45" h. seat: 18" d 19" h.

 double corner blocks: glued & screwed

 high density foam seats: contract quality

6419

raleigh

Wing chair **sup6419**

a touch of california modernism. sheltering wings and a quality of airy freedom meet in its design, and it looks great in contemporary rooms. The tight seat, padded back add up to comfort. kiln dried hardwood frame is double-doweled, glued and screwed for enduring wear. generously padded frame and deep, high density foam cushion, hand tacked antique brass nail heads bring out the best in every line.



Cover: Woolrich.
Colour: Rock.
Finish: Espresso. Antique
Brass Nail Heads

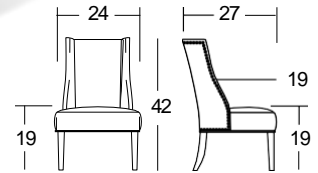

carton size: overall: 25" w 29" d 44" h

carton Weight: 29 lbs

carton cube: 18.46cu.ft.

Packed: 2 items/carton

wing chair overall: 24" w 27" d 42" h. seat: 19" d 19" h.

 double corner blocks: glued & screwed

 high density foam seats: contract quality

6319

murray

Wing chair **sup6319**

The murray wing chair features a refined combination of finish and colour. The quality and richness of its component materials, both for the body and the base, make it particularly elegant and sophisticated. ideal for the home, in dining rooms, but it also fits nicely into offices as a representative chair in the meeting room or in waiting areas.



Cover: Woolrich.
Colour: Rock.
Finish: Espresso. Antique
Brass Nail Heads

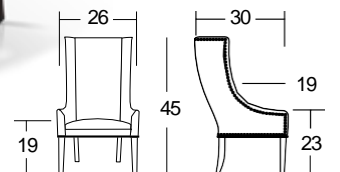

carton size: overall: 26" w 30" d 45" h

carton Weight: 57 lbs

carton cube: 20.31 cu.ft.

Packed: 2 items/carton

wing chair overall: 26" w 30" d 45" h. seat: 19" d 19" h. arm: 23" h.



reclaimed Timber: hand sanded & finished



kiln-dried Timber



metal: 30% recycled content

sc
1465

jacques

bistro side chair **sc1465**

iron frame for an industrial imperfect look. This item is artisan crafted. The patina of the reclaimed wood bears the hallmarks of old wood with nicks, imperfections, marks that reveal their provenance. knots, gouges, cracks, nail holes, cupping and/or slight bowing are inherent characteristics of this wood product and does not constitute damage/defects.



Finish: Reclaimed Wood - Old Elm. Rustiic Iron

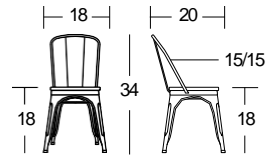

carton size: overall: 19" w 37" d 21" h

carton Weight: 17 lbs

carton cube: 8.54 cu. ft.

Packed: 2 items/carton

side chair overall: 18" w 20" d 34" h. seat: 15" d 18" h.



reclaimed Timber: hand sanded & finished



kiln-dried Timber



metal: 30% recycled content

sc
1466

jacques

bistro counter stool **sc1466**

iron frame for an industrial imperfect look. This item is artisan crafted. The patina of the reclaimed wood bears the hallmarks of old wood with nicks, imperfections, marks that reveal their provenance. knots, gouges, cracks, nail holes, cupping and/or slight bowing are inherent characteristics of this wood product and does not constitute damage/defects.



Finish: Reclaimed Wood - Old Elm. Rustiic Iron

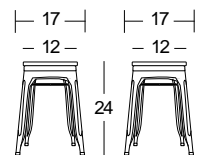

carton size: overall: 17" w 17" d 25" h

carton Weight: 13 lbs

carton cube: 13 cu. ft.

Packed: 1 item/carton

counter stool overall: 17" w 17" d 24" h. seat: 12" w 12" d 25" h.



reclaimed Timber: hand sanded & finished



kiln-dried Timber



metal: 30% recycled content

hsc
721

gorney

side chair **sc721**

reclaimed wood frame for an imperfect look. This item is artisan crafted. The patina of the reclaimed wood bears the hallmarks of old wood with nicks, imperfections, marks that reveal the tables provenance. knots, gouges, cracks, nail holes, cupping and/or slight bowing are inherent characteristics of this wood product and does not constitute damage/defects. claims will not be considered for these characteristics.



Cover: Rattan.
Finish: Reclaimed Wood
Antique Natural.

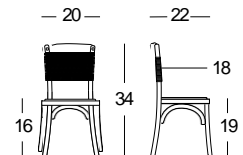

carton size: overall: 21" w 25" d 40" h

carton Weight: 30 lbs

carton cube: 12.15cu.ft.

Packed: 2 items/carton

side chair overall: 20" w 22" d 34" h. seat: 16" d 17" h.



reclaimed Timber: hand sanded & finished



kiln-dried Timber



metal: 30% recycled content

hsc
1365

deon

industrial adjustable
counter/bar stool **sc1365**

an industrial show-stopper, this cast iron adjustable stool is the king of comfort while retaining an air of innate style. superior craftsmanship means a rustic cast iron frame paired with reclaimed solid hardwood for a finish that feels at once weathered and modern. perfect for an industrial loft space but also at home in a more streamlined modern abode, this is a stool that perfectly marries design and comfort. use as bar seating at the counter, or line them up along an oversized dining table.

Finish: Reclaimed Wood -
Old Elm, Rustic Iron

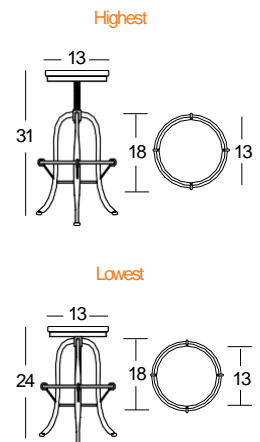

carton size: overall: 17" w 17" d 26" h

carton Weight: 22 lbs

carton cube: 4.35cu.ft.

Packed: 1 item/carton

adjustable stool overall: 22" w 26" d 45" h. seat: 18" d 19" h.



reclaimed Timber: hand sanded & finished



kiln-dried Timber



metal: 30% recycled content

sc
51

re va

cross back side chair **sc51**

iron frame for an industrial imperfect look. This item is artisan crafted. The patina of the reclaimed wood bears the hallmarks of old wood with nicks, imperfections, marks that reveal their provenance. knots, gouges, cracks, nail holes, cupping and/or slight bowing are inherent characteristics of this wood product and does not constitute damage/defects.



Cover: Rattan.
Finish: Reclaimed Wood -
Antique Oak, Rustic Iron.

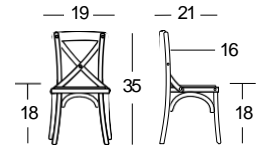

carton size: overall: 21" w 25" d 40" h

carton Weight: 30 lbs

carton cube: 12.15 cu. ft.

Packed: 2 items/carton

side chair overall: 19" w 21" d 35" h. seat: 16" d 18" h.



reclaimed Timber: hand sanded & finished



kiln-dried Timber



metal: 30% recycled content

sc
55/93

re va

cross back
arm chair



re va

cross back
counter stool

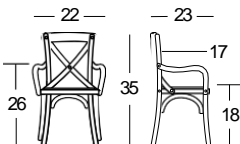

sc93 arm chair

Cover: Rattan. Finish: Reclaimed
Wood - Antque Oak, Rustic Iron.

sc55 counter stool

Cover: Rattan. Finish: Reclaimed
Wood - Antque Oak, Rustic Iron.

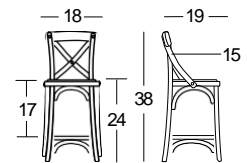

sc93 arm chair

carton size: overall: 22" w 38" d 22" h

carton Weight: 40 lbs

carton cube: 10.64 cu. ft.

Packed: 1 item/carton

sc55 counter stool

carton size: overall: 18" w 40" d 18" h

carton Weight: 19 lbs

carton cube: 7.50 cu. ft.

Packed: 1 item/carton



Foot Stools, BENCHES + ottomANS

a stool or a bench is a great solution for small spaces or mud rooms that need a place to sit. if you've spotted a place that could benefit from a bench, you've come to the right place. made of fine, well crafted textiles, rich warm finishes - these stools and benches embody true understatement, characterized by an impressive atmosphere.

 high density foam seat

 full circumference welds: contract quality

 **sht
282**

yves cosMoPolitan bench **sht282**

The beauty of the yves collection is in its transparency and reflective surfaces. They possess the highest degree of optical clarity thanks to the finest quality acrylic. This acrylic will never yellow or become cloudy, ensuring the beauty and elegance will never fade. while its shape is simple, this bench offers a look of luxury to any space.



Cover: Synthetic Leather. Colour: Dove Gray. Finish: Clear Acrylic, Polished Stainless Steel.

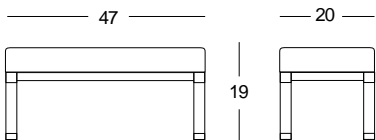

carton size: overall: 51" w 24" d 21" h

carton Weight: 49 lbs

carton cube: 14.88 cu. ft.

Packed: 1 items/carton

bench overall: 47" w 20" d 19" h. seat: 20" d 19" h.

**resimercial
Furniture**

DESIGN FOR TODAY



o CCASIo NAL ACCENTs

a new language of objects with shapes that offer an original interpretation of the need for style or comfort. soft and hard materials, especially in their new versions with colours that bring immediate vitality to the home.



reclaimed timber: hand sanded & finished



kiln-dried timber



metal: 30% recycled content



pollen

live-edge desk 98253

simple in design but beautiful to behold you are sure to be sold on this live edge writing desk. just like no two trees are identical you will find that each desk has its own unique edges. our sedona light walnut finish brings out the richness of the solid acacia wood top and pair beautifully with the trestle style iron legs. pull up a chair and get to work!



Finish: Acacia Wood - Sedona Light
Walnut, Cast Iron - Matte Black.

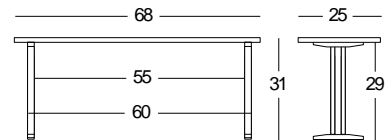

carton size: overall: 71" w 27" d 9" h

carton Weight: 128 lbs

carton cube: 9.98 cu.ft.

Packed: 1 item/carton

desk overall: 68" w 25" d 31" h.

Tempered glass: 3c certification standard

full circumference welds: contract quality



allure

glass top coffee table **scb382**

a future classic and object of desire. elements of style and modern tradition combined with the highest quality and craftsmanship to create furniture that is truly unique. elegant details with a modern flair. despite its simplicity, allows for a personal approach that leaves room for a variety of subtlety.



Finish: Clear Tempered Glass,
Gold Powder Coated Steel.

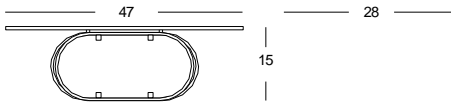

coffee table. overall: 47"w 28"d 15"h.

scb382	glass top	carton size: overall: 49"w 29"d 2"h	carton Weight: 59 lbs	carton cube: 1.66 cu.ft.	Packed: 1 item/carton
	frame	carton size: overall: 38"w 22"d 14"h	carton Weight: 24 lbs	carton cube: 6.81 cu.ft.	Packed: 1 item/carton

Tempered glass: 3c certification standard

full circumference welds: contract quality



jour

glass top coffee table **scb3002**

a future classic and object of desire. elements of style and modern tradition combined with the highest quality and craftsmanship to create furniture that is truly unique. elegant details with a modern flair. despite its simplicity, allows for a personal approach that leaves room for a variety of subtlety.



Finish: Clear Tempered Glass,
Gold Powder Coated Steel.

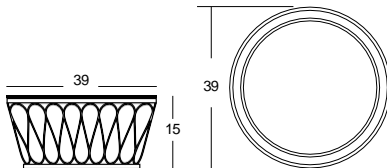

coffee table overall: 39"w 39"d 15"h.

scb3002	glass top	carton size: overall: 41"w 41"d 2"h	carton Weight: 55 lbs	carton cube: 1.66 cu.ft.	Packed: 1 item/carton
	frame	carton size: overall: 40"w 40"d 15"h	carton Weight: 24 lbs	carton cube: 13.38 cu.ft.	Packed: 1 item/carton

Tempered glass: 3c certification standard

full circumference welds: contract quality



toola

glass top coffee table **scb3004**

a future classic and object of desire. elements of style and modern tradition combined with the highest quality and craftsmanship to create furniture that is truly unique. elegant details with a modern flair. despite its simplicity, allows for a personal approach that leaves room for a variety of subtlety.



Finish: Clear Tempered Glass,
Gold Powder Coated Steel.

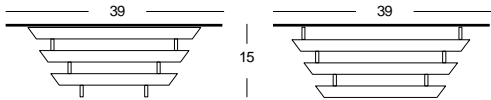

coffee table. overall: 39"w 39"d 15"h.

scb3004	glass top	carton size: overall: 41"w 41"d 2"h	carton Weight: 70 lbs	carton cube: 1.94 cu.ft.	Packed: 1 item/carton
	frame	carton size: overall: 36"w 36"d 14"h	carton Weight: 33 lbs	carton cube: 10.84 cu.ft.	Packed: 1 item/carton

Tempered glass: 3c certification standard

full circumference welds: contract quality



pure

glass top coffee table **scb3007**

a future classic and object of desire. elements of style and modern tradition combined with the highest quality and craftsmanship to create furniture that is truly unique. elegant details with a modern flair. despite its simplicity, allows for a personal approach that leaves room for a variety of subtlety.



Finish: Clear Tempered Glass,
Gold Powder Coated Steel.

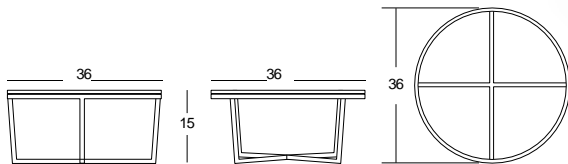

coffee table overall: 36"w 36"d 15"h.

scb3007	glass top	carton size: overall: 37"w 37"d 2"h	carton Weight: 44 lbs	carton cube: 1.59 cu.ft.	Packed: 1 item/carton
	frame	carton size: overall: 35"w 28"d 15"h	carton Weight: 12 lbs	carton cube: 8.47 cu.ft.	Packed: 1 item/carton

Tempered glass: 3c certification standard

high quality electroplating: meets u.s. epa product standards



f a y e

Modern coffee table **so1440**

inspired by the dynamism of a crystalline element, like the geometries of falling snow flakes. its original look furnishes the living area with a touch of essential harmony. The symmetrical shape – a synthesis of personality and elegance, perfectly matches with the lightness of the glass top. rigour and fluidity is the combination from which arises a table that gets its strength from the contrasts: glass and metal, curves and lines, warm and cold materials.

overall: 43" w 43" d 16" h.



Finish: Clear Tempered Glass, Brass Titanized Stainless Steel.

so2440 Finish: Clear Tempered Glass, Polished Stainless Steel.

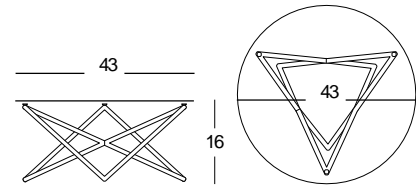

table	glass top	carton size: overall: 46" w 46" d 2" h	carton Weight: 50 lbs	carton cube: 2.45 cu.ft	Packed: 1 item/carton
	frame	carton size: overall: 35" w 35" d 19" h	carton Weight: 12 lbs	carton cube: 13.47 cu.ft.	Packed: 1 item/carton

high quality electroplating: meets u.s. epa product standards

book matched wood veneer: meets hpva standards



l a n d o

Modern coffee & end tables

The round wood and brass stainless steel coffee table has been designed with elegance in mind: a 4" thick espresso veneered wood top nestled within a 5 mil brass titanized stainless steel frame. its asymmetrical shape, synthesis of personality and elegance, perfectly contrast with the thickness of the wood top.



Finish: Brass Titanized Stainless Steel, Espresso.

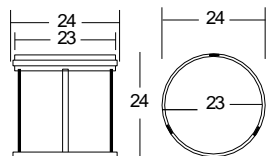

so1451 end Table. overall: 24" w 24" d 24" h.

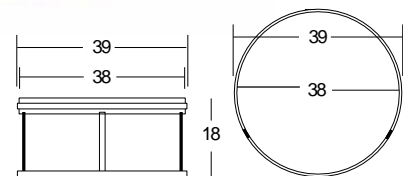

so1450 coffee Table. overall: 39" w 39" d 18" h.

so1451	end table	carton size: overall: 25" w 24" d 7" h	carton Weight: 29 lbs	carton cube: 2.43 cu.ft.	Packed: 1 item/carton
so1450	coffee table	carton size: overall: 53" w 29" d 7" h	carton Weight: 62 lbs	carton cube: 6.43 cu.ft.	Packed: 1 item/carton



yves

cosMoPolitan square
coffee table **sht275**

add a simple, modern look to your indoor living space with this uniquely designed clear acrylic coffee table. The clear color allows for functionality, while not overtaking other furnishings. its subtle and elegant aura makes it the perfect choice for any decor style. mirrored shelf provides the perfect spot for your books and magazines.



Finish: Polished Stainless, Clear Tempered Glass, Clear Acrylic, Mirror.

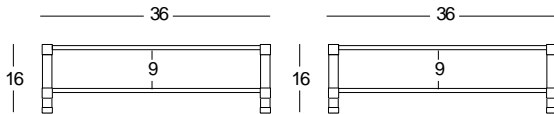

coffee table. overall: 36"w 36"d 16"h.

sht275	glass top	carton size: overall: 34"w 34"d 2"h	carton Weight: 56 lbs	carton cube: 1.34 cu.ft.	Packed: 2 items/carton
	frame	carton size: overall: 42"w 42"d 20"h	carton Weight: 46 lbs	carton cube: 20.42 cu.ft.	Packed: 1 item/carton



yves

cosMoPolitan square
coffee table **sht273**

add a simple, modern look to your indoor living space with this uniquely designed clear acrylic coffee table. The clear color allows for functionality, while not overtaking other furnishings. its subtle and elegant aura makes it the perfect choice for any decor style. mirrored shelf provides the perfect spot for your books and magazines.



Finish: Polished Stainless, Clear Tempered Glass, Clear Acrylic, Mirror.

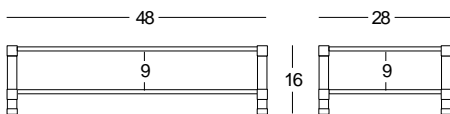

coffee table. overall: 48"w 28"d 16"h.

sht273	glass top	carton size: overall: 26"w 46"d 2"h	carton Weight: 69 lbs	carton cube: 1.38 cu.ft.	Packed: 2 items/carton
	frame	carton size: overall: 32"w 51"d 19"h	carton Weight: 45 lbs	carton cube: 17.94 cu.ft.	Packed: 1 item/carton

Tempered glass: 3c certification standard

mold, impact & sunlight resistant acrylic: contract quality



yves

cosMoPolitan end table sht274

add a simple, modern look to your indoor living space with this uniquely designed clear acrylic coffee table. The clear color allows for functionality, while not overtaking other furnishings. its subtle and elegant aura makes it the perfect choice for any decor style. mirrored shelf provides the perfect spot for your books and magazines.



Finish: Polished Stainless, Clear Tempered Glass, Clear Acrylic, Mirror.

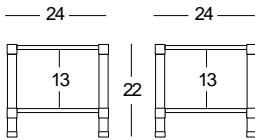

end table. overall: 24"w 24"d 22"h.

sht274	glass top	carton size: overall: 21"w 21"d 3"h	carton Weight: 22 lbs	carton cube: 0.77 cu.ft.	Packed: 2 items/carton
	frame	carton size: overall: 26"w 26"d 24"h	carton Weight: 39 lbs	carton cube: 9.39 cu.ft.	Packed: 1 item/carton

Tempered glass: 3c certification standard

mold, impact & sunlight resistant acrylic: contract quality



yves

cosMoPolitan console table sht272

The beauty of the yves table collection is in its transparency and reflective surfaces. This table possesses the highest degree of optical clarity thanks to the finest quality acrylic. The acrylic will never yellow or become cloudy, ensuring the beauty and elegance of your table will never fade.



Finish: Polished Stainless, Clear Tempered Glass, Clear Acrylic.

shown with sht282 yves bench: overall: 47"w 20"d 19"h.

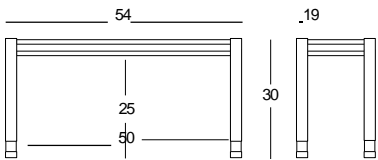

console table. overall: 54"w 19"d 30"h.

sht272	glass top	carton size: overall: 52"w 17"d 2"h	carton Weight: 33 lbs	carton cube: 1.02 cu.ft.	Packed: 1 item/carton
	frame	carton size: overall: 22"w 56"d 32"h	carton Weight: 33 lbs	carton cube: 22.81 cu.ft.	Packed: 1 item/carton

Tempered glass: 3c certification standard

mold, impact & sunlight resistant acrylic: contract quality



yves

cosMoPolitan bar trolley **sht276**

your favorite finds will float on this clear modern bar trolley. built with luminous tempered glass, mirror, highest degree of optical clear acrylic and reinforced with gleaming polished stainless steel accents for a brilliant definition. light, airy and elegant, small yet mighty with lots of style and features a tubular frame and two stacked shelves. caster wheels take the look from bar to kitchen to dining room with ease.

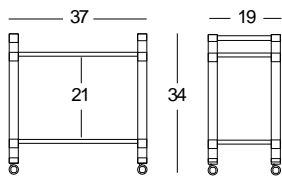

bar trolley. overall: 37"w 19"d 34"h.



Finish: Polished Stainless, Clear Tempered Glass, Clear Acrylic, Mirror.

sht276	glass top	carton size: overall: 34"w 16"d 2"h	carton Weight: 30 lbs	carton cube: 0.63 cu.ft.	Packed: 2 items/carton
	frame	carton size: overall: 40"w 22"d 33"h	carton Weight: 33 lbs	carton cube: 16.81 cu.ft.	Packed: 1 item/carton

Tempered glass: 3c certification standard

mold, impact & sunlight resistant acrylic: contract quality



yves

cosMoPolitan square coffee table **sht273**

add a simple, modern look to your indoor living space with this uniquely designed clear acrylic coffee table. The clear color allows for functionality, while not overtaking other furnishings. its subtle and elegant aura makes it the perfect choice for any decor style. mirrored shelf provides the perfect spot for your books and magazines.

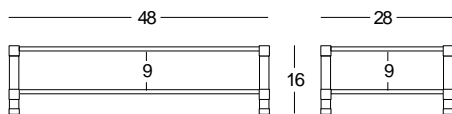

coffee table. overall: 48"w 28"d 16"h.



Finish: Polished Stainless, Clear Tempered Glass, Clear Acrylic, Mirror.

sht273	glass top	carton size: overall: 26"w 46"d 2"h	carton Weight: 69 lbs	carton cube: 1.38 cu.ft.	Packed: 2 items/carton
	frame	carton size: overall: 32"w 51"d 19"h	carton Weight: 45 lbs	carton cube: 17.94 cu.ft.	Packed: 1 item/carton

 kiln dried, plantation grown hardwood

 fibre reinforced concrete

 soft-close full extension drawer glides

gh
3172

rockhampton

concrete to P buffet **g 3172**

contemporary elegance, form and function combine with superior craftsmanship. reinforced hollow core concrete table top atop an acacia hardwood box frame. it's durable and aesthetically attractive. stunning colouration and lines, unique design that will compliment any room furnishing. environmentally friendly water based lacquer that is free from conventional toxins. made from plantation grown acacia hardwood and veneers, kiln dried and treated.



*Finish: Acacia Wood - Weathered Grey,
Reinforced Gray Concrete*

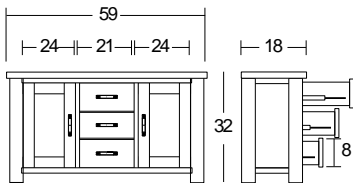

carton size: overall: 63"w 21"d 36"h

carton Weight: 161 lbs

carton cube: 27.56 cu.ft.

Packed: 1 item/carton

buffet overall: 59"w 18"d 32"h. 2 doors, 3 drawers.

 book matched wood veneer: meets hpva standards

 kiln-dried Timber

 metal: 30% recycled content

sc
1733

mansfield

3-door Modern buffet **68213**

ethereal in appearance. meticulously made by master cabinetmakers, wrapped in brass with a hammered cosmocentric debossed sunburst design that catches and reflects the light to strike a visually pleasing balance. its sleek modern box frame finished in a dark rich wood tone, sits atop slender tapered legs to give a mid century modern feel. european self adjusting hinges are concealed, and interior shelves make it hard to resist.



*Finish: Dark Mango,
Brass Plated Metal.*

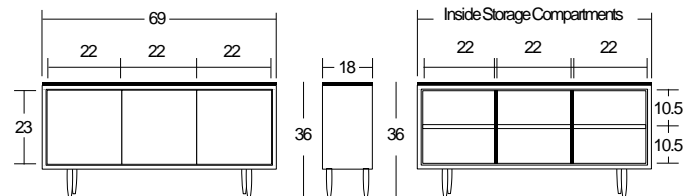

carton size: overall: 46"w 20"d 36"h

carton Weight: 192 lbs

carton cube: 19.17 cu.ft.

Packed: 1 item/carton

buffet overall: 69"w 18"d 36"h. 3 brass Toned doors.

resimercial
Furniture

DESIGN FOR TODAY



reclaimed Timber: hand sanded & finished



kiln-dried Timber



metal: 30% recycled content



miklen

x-base console table **sc1743**

with crisp, clean lines and sophisticated, minimalist design, this table is the epitome of modern rusticity. features an x-shaped base that gives the piece its modern edge. antiqued silver finish gives the base a soft hue while a rustic wood top adds contrast to the elegant frame. The piece articulates a commanding presence, making it the perfect centerpiece to a contemporary living room.



Collection Includes: Coffee table (SC1745), End Table (SC1744), Console Table (SC1743), Dining Table (SC1746).

Finish: Reclaimed Wood - Weathered Gray Pine, Antiqued Silver Iron.

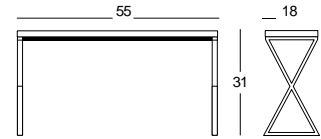

carton size: overall: 57" w 19" d 5" h

carton Weight: 51 lbs

carton cube: 3.13 cu.ft.

Packed: 1 item/carton

console table overall: 55" w 18" d 31" h.



reclaimed Timber: hand sanded & finished



kiln-dried Timber



metal: 30% recycled content



miklen

coffee & end tables

iron frame for an industrial imperfect look. The patina of the reclaimed wood bears the hallmarks of old wood with nicks, imperfections, marks that reveal the furniture's provenance.



Finish: Reclaimed Wood - Weathered Gray Pine, Antiqued Silver Iron.

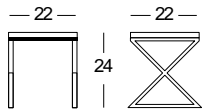

sc1744 end Table. overall: 22" w 22" d 24" h.

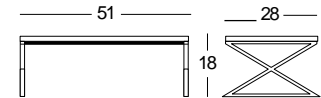

sc1745 coffee Table. overall: 51" w 28" d 18" h.

sc1744 end table

carton size: overall: 25" w 24" d 7" h

carton Weight: 29 lbs

carton cube: 2.43 cu.ft.

Packed: 1 item/carton

sc1745 coffee table

carton size: overall: 53" w 29" d 7" h

carton Weight: 62 lbs

carton cube: 6.43 cu.ft.

Packed: 1 item/carton



reclaimed Timber: hand sanded & finished



kiln-dried Timber



metal: 30% recycled content



ripley

Parquet top console table **sc1672**

rough-hewn planks are carefully hand-selected, planed and sanded. The patina of the reclaimed wood bears the hallmarks of old wood with nicks, imperfections, marks that reveal the unit's provenance. knots, gouges, cracks, nail holes, cupping and/or slight bowing are inherent characteristics of this wood product and does not constitute damage/defects. claims will not be considered for these characteristics.

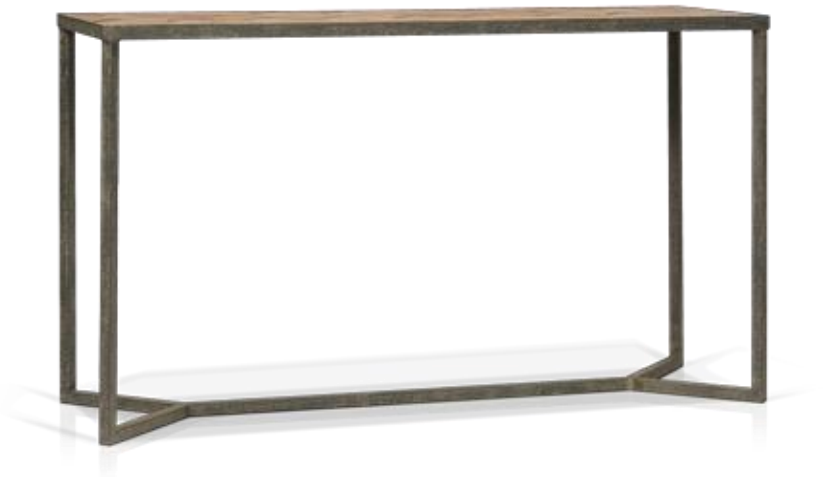

Finish: Reclaimed Wood - Old Pine, Rustic Iron.

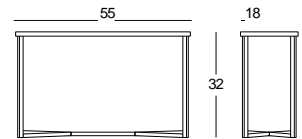

carton size: overall: 57" w 20" d 33" h
carton cube: 21.01 cu.ft.

carton Weight: 40 lbs
Packed: 1 item/carton

console table overall: 55" w 18" d 32" h.



reclaimed Timber: hand sanded & finished



kiln-dried Timber



metal: 30% recycled content



ripley

coffee & end tables

iron frame for an industrial imperfect look. The patina of the reclaimed wood bears the hallmarks of old wood with nicks, imperfections, marks that reveal the furniture's provenance.



Finish: Reclaimed Wood - Old Pine, Rustic Iron.

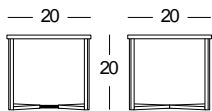

sc1673 end Table. overall: 20" w 20" d 20" h.

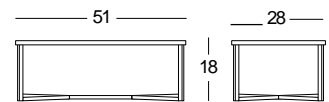

sc1671 coffee Table. overall: 51" w 28" d 18" h.

sc1673 end table carton size: overall: 22" w 22" d 22" h

carton Weight: 40 lbs

carton cube: 6.16 cu.ft.

Packed: 1 item/carton

sc1671 coffee table carton size: overall: 53" w 29" d 20" h

carton Weight: 42 lbs

carton cube: 17.79 cu.ft.

Packed: 1 item/carton



reclaimed Timber: hand sanded & finished



kiln-dried Timber



metal: 30% recycled content



olie

coffee table **sc517**

iron frame for an industrial imperfect look. This item is artisan crafted. The patina of the reclaimed wood bears the hallmarks of old wood with nicks, imperfections, marks that reveal the furniture's provenance. knots, gouges, cracks, nail holes, cupping and/or slight bowing are inherent characteristics of this wood product and does not constitute damage/defects.



Finish: Reclaimed Wood - Old Pine, Rustic Iron, Antique Brass Handles.

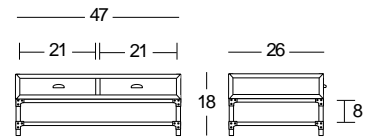

carton size: overall: 49"w 28"d 20"h
carton cube: 15.88 cu.ft.

carton Weight: 83 lbs
Packed: 1 item/carton

coffee table overall: 47"w 26"d 18"h. 2 drawers, 1 open metal shelf.



parlour

tree stump tables

handcrafted by artisans, the hammered antiqued finish surfaces transforms this collection into an absolute eye-catcher. Timeless, versatile and with terrific design quality – the subtle contours and sturdiness of the design, constructed with aluminium and coated in antique bronze or rustic black antique finishes.

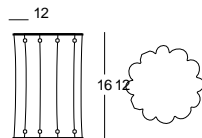

svc2556 accent Table.
overall: 12"w 12"d 16"h.

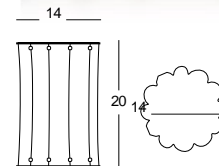

svc2557 accent Table.
overall: 14"w 14"d 20"h.

Finish: Champagne (Hammered Iron)
- Powder Coated Metal.

svc2556 accent table **carton size:** overall: 14"w 13"d 18"h
svc2557 accent table **carton size:** overall: 15"w 16"d 22"h

carton Weight: 14 lbs
carton Weight: 16 lbs

carton cube: 1.90 cu.ft.
carton cube: 3.06 cu.ft.

Packed: 1 item/carton
Packed: 1 item/carton



wilmore

3-tier nesting tables 93413

nesting tables are such an important part of any home decor. They provide a little extra table space without taking up a lot of area in your home. The wilmore 3-tier nesting tables have smooth marble tops set on slim extruded iron box frames. a smart solution for smaller rooms, they tuck inside one another when you need to save space.



Finish: White Marble, Black Powder Coated Steel.

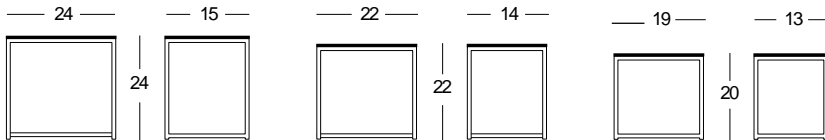

carton size: overall: 27" w 18" d 28" h
carton cube: 7.88 cu.ft.

carton Weight: 81 lbs
Packed: 3 Tables/carton

lrg: overall: 24" w 15" d 24" h.
sml: overall: 19" w 13" d 20" h.

med: overall: 22" w 14" d 22" h.



tokko

coffee & end tables

simple shapes and a minimalist metal frame make this piece ideal for a modern interior. aesthetically pleasing, this table draws its beauty from its simple forms and geometric lines producing an uncomplicated, harmonious architecture.



Finish: White Marble, Black Powder Coated Steel.

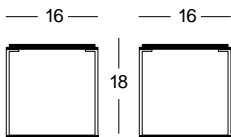

scq1501 end Table. overall: 16" w 16" d 18" h.

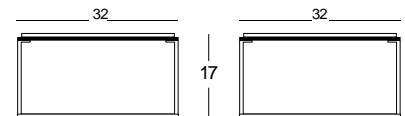

scq1502 coffee Table. overall: 32" w 32" d 17" h.

scq1501 end table **carton size:** overall: 22" w 19" d 4" h
scq1502 coffee table **carton size:** overall: 37" w 34" d 4" h

carton Weight: 24 lbs
carton Weight: 79 lbs

carton cube: 1.14 cu.ft.
carton cube: 3.22 cu.ft.

Packed: 1 item/carton
Packed: 1 item/carton

Tempered glass: 3c certification standard

full circumference welds: contract quality



diamond

glass to P coffee table **sef11530**

a future classic and object of desire. elements of style and modern tradition combined with the highest quality and craftsmanship to create furniture that is truly unique. elegant details with a modern flair. despite its simplicity, allows for a personal approach that leaves room for a variety of subtlety.

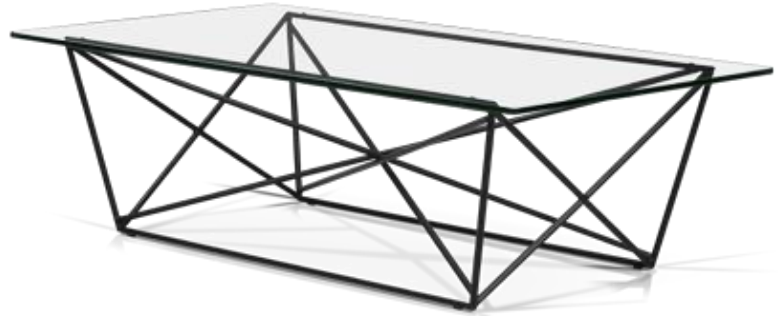

Collection Includes: End Table (SEf11531), Dining Table (SEf2203)

Finish: Clear Tempered Glass, Black Powder Coated Steel.

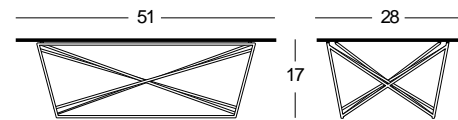

sef11531 coffee Table. overall: 51" w 28" d 17" h.

sef11530 glasstop	carton size: overall: 54" w 30" d 2" h	carton Weight: 70 lbs	carton cube: 1.88 cu.ft.	Packed: 1 item/carton
frame	carton size: overall: 44" w 25" d 17" h	carton Weight: 11 lbs	carton cube: 10.82 cu.ft.	Packed: 1 item/carton

Tempered glass: 3c certification standard

full circumference welds: contract quality



diamond

glass to P end table **sef11531**

a future classic and object of desire. elements of style and modern tradition combined with the highest quality and craftsmanship to create furniture that is truly unique. elegant details with a modern flair. despite its simplicity, allows for a personal approach that leaves room for a variety of subtlety.

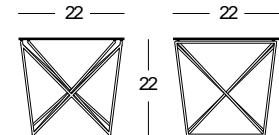

Finish: Clear Tempered Glass, Black Powder Coated Steel.

sef11531 end Table. overall: 22" w 22" d 22" h.

sef11531 glass top	carton size: overall: 24" w 24" d 2" h	carton Weight: 19 lbs	carton cube: 1.88 cu.ft.	Packed: 1 item/carton
frame	carton size: overall: 23" w 23" d 23" h	carton Weight: 24 lbs	carton cube: 7.04 cu.ft.	Packed: 1 item/carton

 high quality electroplating: meets u.s. epa product standards

 book matched wood veneer: meets hpva standards

sef
tbls

ensol

accent & console tables

designed specifically for modern and contemporary homes. it will also blend well in an industrial setting. This piece of decor is sleek in design and sure to impress your guests. beautifully proportioned and delicate in scale. low, slim, and chic, while the gunmetal finished frame provide a casual flair.



*Finish: Smoked Oak,
Gun Metal Gray - Powder
Coated Steel.*

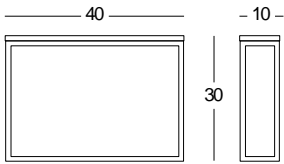

sef267 console Table. overall: 40" w 10" d 30" h.

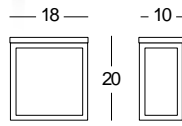

sef264 accent Table. overall: 18" w 10" d 20" h.

sef264 accent table carton size: overall: 20" w 12" d 22" h

carton Weight: 19 lbs

carton cube: 3.06 cu.ft.

Packed: 1 item/carton

sef267 console table carton size: overall: 41" w 12" d 32" h

carton Weight: 28 lbs

carton cube: 9.11 cu.ft.

Packed: 1 item/carton

 high quality electroplating: meets u.s. epa product standards

 book matched wood veneer: meets hpva standards

sef
tbls

bergen

coffee & end tables

iron frame for an industrial imperfect look. The patina of the reclaimed wood bears the hallmarks of old wood with nicks, imperfections, marks that reveal the furniture's provenance.



*Finish: Smoked Oak,
Gun Metal Gray -
Powder Coated Steel.*

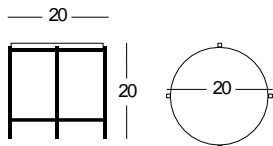

sef2532 end Table. overall: 20" w 20" d 20" h.

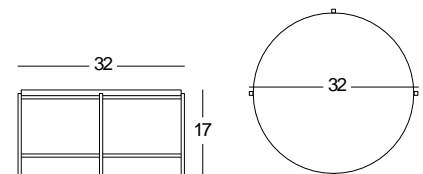

sef2531 coffee Table. overall: 32" w 32" d 17" h.

sef2532 end table carton size: overall: 22" w 22" d 22" h

carton Weight: 14 lbs

carton cube: 6.16 cu.ft.

Packed: 1 item/carton

sef2531 coffee table carton size: overall: 34" w 34" d 18" h

carton Weight: 26 lbs

carton cube: 12.04 cu.ft.

Packed: 1 item/carton

resimercial
Furniture

DESIGN FOR TODAY

high quality electroplating: meets u.s. epa product standards

book matched wood veneer: meets hpva standards



jackie

Walnut top coffee table **spd2090**

The landscapes of the desert southwest are marked by sweeping vistas, exquisite rock formations and a rich palate of colours – an inspiration for this striking end table. The thick solid wood table top echoes the deep earth tones found throughout the southwest and gives this piece a distinct look. The smooth, clean lines are meant to evoke the peaceful, windswept calm of a desert at dusk, while the brass finish adds an extra touch of authenticity and style.

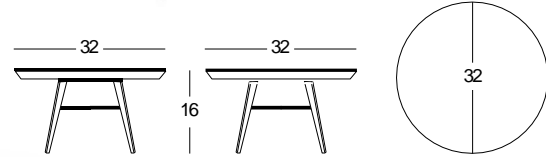

coffee table overall: 32”w 31”d 16”h.

Finish: Brass Anodized
Brushed Steel, Walnut.

spd2090	Woodtop	carton size: overall: 33”w 33”d 2”h	carton Weight: 29 lbs	carton cube: 1.41 cu.ft.	Packed: 1 item/carton
	frame	carton size: overall: 18”w 18”d 15”h	carton Weight: 6 lbs	carton cube: 2.72 cu.ft.	Packed: 1 item/carton

high quality electroplating: meets u.s. epa product standards

book matched wood veneer: meets hpva standards



jackie

Walnut top coffee table **spd2091**

The landscapes of the desert southwest are marked by sweeping vistas, exquisite rock formations and a rich palate of colours – an inspiration for this striking end table. The thick solid wood table top echoes the deep earth tones found throughout the southwest and gives this piece a distinct look. The smooth, clean lines are meant to evoke the peaceful, windswept calm of a desert at dusk, while the brass finish adds an extra touch of authenticity and style.

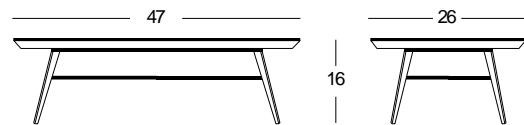

coffee table overall: 47”w 26”d 16”h.

Finish: Brass Anodized
Brushed Steel, Walnut.

spd2091	Woodtop	carton size: overall: 49”w 28”d 2”h	carton Weight: 44 lbs	carton cube: 1.41 cu.ft.	Packed: 1 item/carton
	frame	carton size: overall: 47”w 22”d 15”h	carton Weight: 9 lbs	carton cube: 8.83 cu.ft.	Packed: 1 item/carton



burlee

Walnut to P end table **spd2080**

The landscapes of the desert southwest are marked by sweeping vistas, exquisite rock formations and a rich palate of colours – an inspiration for this striking end table. The thick solid wood table top echoes the deep earth tones found throughout the southwest and gives this piece a distinct look. The smooth, clean lines are meant to evoke the peaceful, windswept calm of a desert at dusk, while the gun metal finish adds an extra touch of authenticity and style.



Finish: Gunmetal - Powder Coated Steel, Walnut.

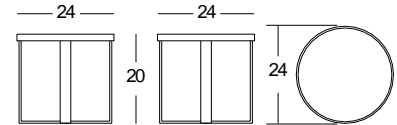

carton size: overall: 25" w 25" d 21" h

carton Weight: 36 lbs

carton cube: 7.62 cu.ft.

Packed: 1 item/carton

end table overall: 24" w 24" d 20" h.



rockhampton

concrete to P console table **g3169**

contemporary elegance, form and function combine with superior craftsmanship. reinforced hollow core concrete table top atop an acacia hardwood box frame. it's durable and aesthetically attractive. stunning colouration and lines, unique design that will compliment any room furnishing. environmentally friendly water based lacquer that is free from conventional toxins. made from plantation grown acacia hardwood and veneers, kiln dried and treated.



Finish: Acacia Wood - Weathered Grey, Reinforced Gray Concrete

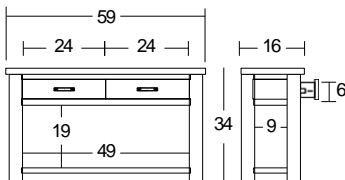

carton size: overall: 63" w 22" d 23" h

carton Weight: 154 lbs

carton cube: 18.45 cu.ft.

Packed: 1 item/carton

console table overall: 59" w 16" d 34" h. 2 drawers, 1 open shelf.

Tempered glass: 3c certification standard

full circumference welds: contract quality



mitzi

cosMoPolitan coffee table **sht518**

delicately composed, this round coffee table has a champagne finished base that is elegantly lustrous. perfect in proportions, possessing modern simplicity, this end table is crafted from steel and tempered glass. The steel legs are dramatically tapered allowing the intersecting curves below to be the star of the show.



Finish: Clear Tempered Glass,
Champagne - Powder Coated Steel.

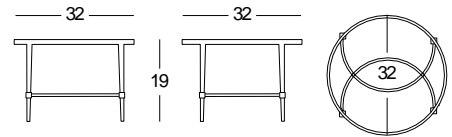

carton size: overall: 57" w 19" d 5" h

carton Weight: 51 lbs

carton cube: 3.13 cu.ft.

Packed: 1 item/carton

coffee table overall: 32" w 32" d 19" h.

Tempered glass: 3c certification standard

full circumference welds: contract quality



mitzi

cosMoPolitan coffee & end tables

perfect in proportions, possessing modern simplicity, these tables are feature high quality steel and clear tempered glass. The steel legs are dramatically tapered allowing the intersecting curves below to be the star of the show.



Finish: Clear Tempered Glass,
Champagne - Powder Coated Steel.

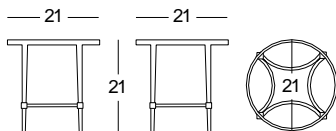

sht523 end Table. overall: 21" w 21" d 21" h.

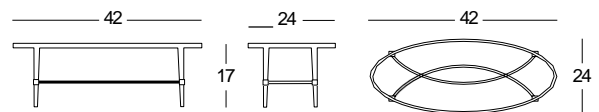

sht524 coffee Table. overall: 42" w 24" d 17" h.

sht523 end table

carton size: overall: 25" w 24" d 7" h

carton Weight: 29 lbs

carton cube: 2.43 cu.ft.

Packed: 1 item/carton

sht524 coffee table

carton size: overall: 53" w 29" d 7" h

carton Weight: 36 lbs

carton cube: 6.43 cu.ft.

Packed: 1 item/carton

☺ Tempered glass: 3c certification standard

☺ full circumference welds: contract quality



lionel

cosMoPolitan end table **sht526**

Finish: Mirror, Champagne
- Powder Coated Steel.

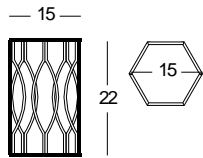

sht526 accent Table. overall: 15"w 15"d 22"h.

gracie

cosMoPolitan end table **sht546**

Finish: Clear Tempered
Glass, Champagne -
Powder Coated Steel.

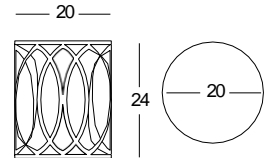

sht546 accent Table. overall: 20"w 20"d 24"h.

sht526 end table

carton size: overall: 14"w 17"d 23"h

carton Weight: 14 lbs

carton cube: 3.00 cu.ft.

Packed: 1 item/carton

sht546 end table

carton size: overall: 21"w 21"d 27"h

carton Weight: 26 lbs

carton cube: 7.0 cu.ft.

Packed: 1 item/carton

☺ Tempered glass: 3c certification standard

☺ full circumference welds: contract quality



lana

cosMoPolitan accent table **sht533**

Finish: Clear Tempered
Glass, Champagne -
Powder Coated Steel.

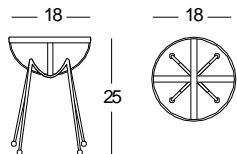

sht533 accent Table. overall: 18"w 18"d 25"h.



bacall

round end table **sha429**

Finish: Clear Tempered
Beveled Glass, Argenta,
Brushed Stainless Accents.

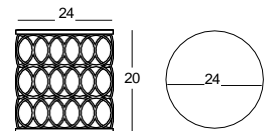

sha429 end Table. overall: 24"w 24"d 20"h.

sht533 accent table

carton size: overall: 19"w 20"d 28"h

carton Weight: 20 lbs

carton cube: 6.16 cu.ft.

Packed: 1 item/carton

sha429 end table

carton size: overall: 24"w 24"d 23"h

carton Weight: 22 lbs

carton cube: 5.75 cu.ft.

Packed: 1 item/carton

Tempered glass: 3c certification standard

full circumference welds: contract quality



carole

round glass top end tables

it's all about inspiring a playful ambiance in any modern setting. This contemporary marvel infuses a retro classic look with a touch of ultra contemporary pizzazz. it adds instant character and style into any setting. it features a base made of stamped steel pattern and powder coated in argenta finish and is perfectly complemented by a clear or gray tempered glass top.

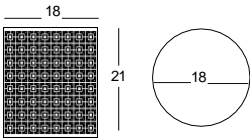

sht512

Finish: Tempered Gray Glass, Argenta, Brushed Stainless Steel Accents.

sht515

Finish: Clear Tempered Glass, Argenta, Brushed Stainless Steel Accents.

carton size: overall: 19" w 20" d 24" h

carton Weight: 30 lbs

carton cube: 5.28 cu. ft.

Packed: 1 item/carton

end table overall: 18" w 18" d 21" h.

Tempered glass: 3c certification standard

full circumference welds: contract quality



reynolds

end table Jlh 701

with crisp, clean lines and sophisticated, minimalist design, the reynolds collection is the epitome of ultra modern style. features an x-shaped shelf base that gives the piece its modern edge. a polished stainless finish gives the base a radiant glow while a sleek glass top adds elegant contrast to the tough, sturdy frame.

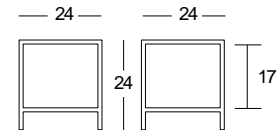

Finish: Clear Tempered Beveled Glass, Polished Stainless Steel.

end table. overall: 24" w 24" d 24" h.

Jlh 701 glass top
frame

carton size: overall: 24" w 24" d 2" h
carton size: overall: 27" w 26" d 26" h

carton Weight: 33 lbs
carton Weight: 19 lbs

carton cube: 0.67 cu. ft.
carton cube: 10.97 cu. ft.

Packed: 2 items/carton
Packed: 1 item/carton

Tempered glass: 3c certification standard

full circumference welds: contract quality



reynolds

console table **JH 702**

with crisp, clean lines and sophisticated, minimalist design, the reynolds collection is the epitome of ultra modern style. features an x-shaped shelf base that gives the piece its modern edge. a polished stainless finish gives the base a radiant glow while a sleek glass top adds elegant contrast to the tough, sturdy frame.

*Finish: Clear Tempered
Beveled Glass, Polished
Stainless Steel.*



console table. overall: 54" w 19" d 30" h.

JH 702	glass top	carton size: overall: 53" w 18" d 2" h	carton Weight: 62 lbs	carton cube: 1.00 cu.ft.	Packed: 2 items/carton
	frame	carton size: overall: 57" w 23" d 32" h	carton Weight: 30 lbs	carton cube: 24.28 cu.ft.	Packed: 1 item/carton

Tempered glass: 3c certification standard

full circumference welds: contract quality



reynolds

coffee table **JH 700**

with crisp, clean lines and sophisticated, minimalist design, the reynolds collection is the epitome of ultra modern style. features an x-shaped shelf base that gives the piece its modern edge. a polished stainless finish gives the base a radiant glow while a sleek glass top adds elegant contrast to the tough, sturdy frame.

*Finish: Clear Tempered
Beveled Glass, Polished
Stainless Steel.*



coffee table. overall: 48" w 28" d 16" h.

JH 700	glass top	carton size: overall: 47" w 28" d 2" h	carton Weight: 84 lbs	carton cube: 1.52 cu.ft.	Packed: 1 items/carton
	frame	carton size: overall: 51" w 31" d 19" h	carton Weight: 30 lbs	carton cube: 17.38 cu.ft.	Packed: 1 item/carton

 full circumference welds: contract quality

 high quality electroplating: meets u.s. epa product standards



leslie

lamp table **sef4062**

a future classic and object of desire. elements of style and modern tradition combined with the highest quality and craftsmanship to create furniture that is truly unique. elegant details with a modern flair. despite its simplicity, allows for a personal approach that leaves room for a variety of subtlety.



*Finish: 19 mm Clear Glass,
Polished Stainless Steel.*

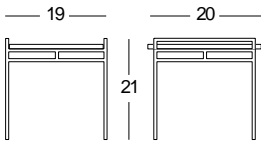

lamp table. overall: 19"w 20"d 21"h.

sef4062 glasstop	carton size: overall: 21"w 20"d 2"h	carton Weight: 23 lbs	carton cube: 0.49 cu.ft	Packed: 1 item/carton
frame	carton size: overall: 21"w 18"d 23"h	carton Weight: 13 lbs	carton cube: 5.03 cu.ft.	Packed: 1 item/carton

 Tempered glass: 3c certification standard

 full circumference welds: contract quality



lella

end table **Jl ef1171**

a future classic and object of desire. elements of style and modern tradition combined with the highest quality and craftsmanship to create furniture that is truly unique. elegant details with a modern flair. despite its simplicity, allows for a personal approach that leaves room for a variety of subtlety.



*Finish: Clear Tempered Glass,
Polished Stainless Steel.*

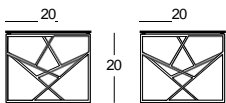

end table. overall: 20"w 20"d 20"h.

Jlef1171 glass top	carton size: overall: 22"w 22"d 2"h	carton Weight: 18 lbs	carton cube: 0.56 cu.ft.	Packed: 1 item/carton
frame	carton size: overall: 22"w 21"d 4"h	carton Weight: 17 lbs	carton cube: 1.07 cu.ft.	Packed: 1 item/carton

☺ Tempered glass: 3c certification standard

☺ full circumference welds: contract quality



Iella

square coffee table **Jlef1172**

a future classic and object of desire. elements of style and modern tradition combined with the highest quality and craftsmanship to create furniture that is truly unique. elegant details with a modern flair. despite its simplicity, allows for a personal approach that leaves room for a variety of subtlety.



Finish: Clear Tempered Glass, Polished Stainless Steel.

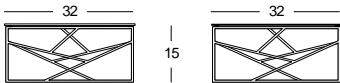

coffee table. overall: 32"w 32"d 15"h.

Jlef1172 glass top	carton size: overall: 33"w 43d 2"h	carton Weight: 39 lbs	carton cube: 1.30 cu.ft.	Packed: 1 item/carton
frame	carton size: overall: 33"w 16"d 4"h	carton Weight: 20 lbs	carton cube: 1.22 cu.ft.	Packed: 1 item/carton

☺ Tempered glass: 3c certification standard

☺ full circumference welds: contract quality



Iella

rectangular coffee table **Jlef1173**

a future classic and object of desire. elements of style and modern tradition combined with the highest quality and craftsmanship to create furniture that is truly unique. elegant details with a modern flair. despite its simplicity, allows for a personal approach that leaves room for a variety of subtlety.



Finish: Clear Tempered Glass, Polished Stainless Steel.

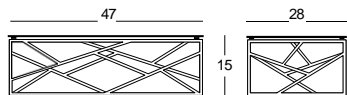

coffee table. overall: 47"w 28"d 15"h.

Jlef1173 glass top	carton size: overall: 49"w 28"d 2"h	carton Weight: 41 lbs	carton cube: 1.64 cu.ft.	Packed: 1 item/carton
frame	carton size: overall: 54"w 16"d 3"h	carton Weight: 20 lbs	carton cube: 1.50 cu.ft.	Packed: 1 item/carton

Tempered glass: 3c certification standard

full circumference welds: contract quality



acrobat

4-tiered, Multi-coloured glass top coffee table **scq1201**

This coffee table inspires a playful ambiance in any modern setting. This contemporary marvel infuses a retro classic look with a touch of ultra contemporary pizzazz. It adds instant character and style into any setting. It features a base made of high quality stainless steel, perfectly complemented by four multi-coloured tempered glass tops.



Finish: Polished Stainless Steel, Coloured Tempered Glass (Magenta, Clear, Cyan, Orange)

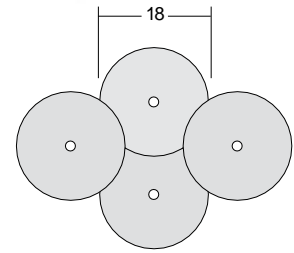
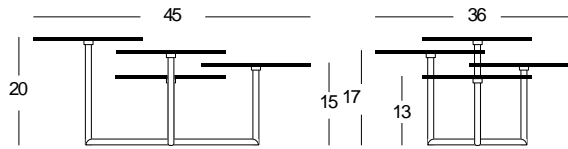

carton size: overall: 29" w 21" d 6" h

carton Weight: 37 lbs

carton cube: 2.11 cu.ft.

Packed: 1 item/carton

coffee table overall: 45" w 36" d 20" h. glass Tops: 18" dia.

Tempered glass: 3c certification standard

full circumference welds: contract quality



host

Wood-block accent table **sef1158**

an elegant piece that beautifully brings nature to the modern home. make a strong impression with this purist design and organic form. Timeless, versatile and with terrific design quality. The architectural angles and sturdiness of the design, constructed with high quality wood veneer.



Finish: Walnut.



carton size: overall: 16" w 39" d 18" h

carton Weight: 42 lbs

carton cube: 6.50 cu.ft.

Packed: 1 item/carton

accent table overall: 14" w 37" d 15" h.



high density foam seat



full circumference welds: contract quality

so
361

montana

rectangular tufted
ottoMan so36109

The lightweight squared structure stainless steel frame supports a padded tufted cushion and gives this bench a contemporary look that pairs well with both traditional and modern design styles. high density foam padding provides guests with a comfortable seating option for times when you need to entertain them.



Cover: Synthetic Leather.
Colour: Black. Finish:
Polished Stainless Steel.

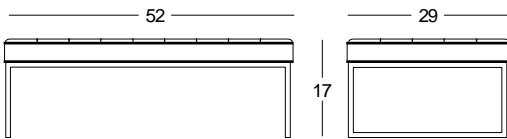

carton size: overall: 53"w 30"d 20"h

carton cube: 18.40cu.ft.

carton Weight: 48 lbs

Packed: 2 items/carton

rectangular ottoman overall: 52"w 29"d 17h. seat: 29"d 17"h



high density foam seat



full circumference welds: contract quality

so
361

montana

square tufted
ottoMan so36162

The lightweight squared structure stainless steel frame supports a padded tufted cushion and gives this bench a contemporary look that pairs well with both traditional and modern design styles. high density foam padding provides guests with a comfortable seating option for times when you need to entertain them.



Cover: Synthetic Leather.
Colour: Vintage Brown.
Finish: Brass Titanized
Stainless Steel.

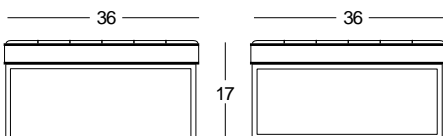

carton size: overall: 37"w 37"d 20"h

carton cube: 15.48cu.ft.

carton Weight: 48 lbs

Packed: 1 items/carton

square ottoman overall: 36"w 36"d 17h. seat: 36"d 17"h.

 high density foam seat

 full circumference welds: contract quality

 **sha**
700

exe

cross-base bench **sha700**

The exe cross-base bench is as elegant as it is comfortable. The lightweight, brass plated brushed stainless steel frame supports a thick padded tufted faux leather cushion. This modern bench easily fits your decor and features a great design that won't go unnoticed.



*Cover: Synthetic Leather.
Colour: Black. Finish: Brass Plated
- Brushed Stainless Steel.*

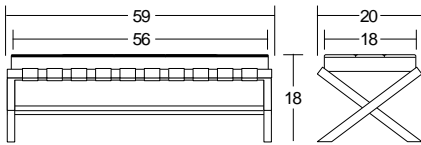

carton size: overall: 60"w 21"d 20"h

carton Weight: 51 lbs

carton cube: 13.78cu.ft.

Packed: 2 items/carton

bench overall: 59"w 20"d 18h. seat: 18"d 18"h.

 high density foam seat

 full circumference welds: contract quality

 **sha**
600

lulie

Modern bench **sha600**

The lulie bench is as elegant as it is comfortable. The lightweight, brass plated brushed stainless steel frame supports a thick padded tufted faux leather cushion. This modern bench easily fits your decor and features a great design that won't go unnoticed.



*Cover: Synthetic Leather.
Colour: Black. Finish: Brass Plated
- Brushed Stainless Steel.*

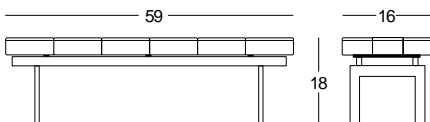

carton size: overall: 61"w 17"d 20"h

carton Weight: 42 lbs

carton cube: 11.93cu.ft.

Packed: 1 items/carton

bench overall: 59"w 16"d 18h. seat: 16"d 18"h.



high density foam seat



full circumference welds: contract quality

sef
308

Lucie

Modern bench **sef3087**

The Lucie bench with side table is as elegant and versatile as it is comfortable. The lightweight, black powder coated steel frame supports a thick padded tufted faux leather cushion and a fixed side table for the convenience of a side table without hassle. This modern bench easily fits your decor and features a great design that won't go unnoticed.



*Cover: Woolrich. Colour: Rock.
Finish: Walnut, Black Powder
Coated Steel.*

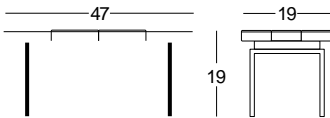

carton size: overall: 50" w 22" d 6" h

carton Weight: 31 lbs

carton cube: 3.82 cu. ft.

Packed: 1 items/carton

bench overall: 47" w 19" d 18" h. seat: 35" w 18" d 18" h. Table: 12" w 12" d

sef
308

Lucie

Modern bench **sef3088**

The lightweight powder coated steel frame supports a plush padded cushion and gives this bench a contemporary look that pairs well with both traditional and modern design styles. The foam padded seat provides guests with a comfortable seating option for times when you need to entertain them. The squared structure of the framing makes the seat stable and capable of being matched with almost any motif or decor.



high density foam seat



full circumference welds: contract quality



*Cover: Synthetic Leather.
Colour: Black. Finish: Black
Powder Coated Steel.*



carton size: overall: 50" w 22" d 6" h

carton Weight: 31 lbs

carton cube: 3.82 cu. ft.

Packed: 1 items/carton

bench overall: 47" w 19" d 18" h. seat: 19" d 19" h.

resimerical
Furniture

DESIGN FOR TODAY



high density foam seat



full circumference welds: contract quality

sha
700

farlow

urban classic bench **sct607b**

The lightweight squared structure stainless steel frame supports a thick padded cushion and gives this bench a contemporary look that pairs well with both traditional and modern design styles. The thick foam padding on the seat provides guests with a comfortable seating option for times when you need to entertain them.



Cover: Tweed. Colour: Heather.
Finish: Brushed Stainless Steel.

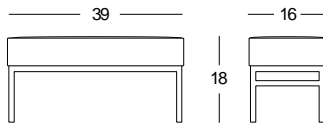

carton size: overall: 21"w 17"d 17"h

carton Weight: 19 lbs

carton cube: 3.51cu.ft.

Packed: 1 item/carton

bench overall: 39"w 16"d 18"h. seat: 16"d 18"h.



reclaimed Timber: hand sanded & finished



kiln-dried Timber



metal: 30% recycled content

sc
385

maydel

cross-base bench **sc385**

rectangle and triangle combine in this bench's rustic metalwork and wood construction for a geometrically intriguing presentation. a distressed old pine seat maintains the vintage-industrial vibe. sturdy construction ensures years of use. The x-frame detail of the legs keeps the design simple and airy while providing good durable seating. The patina of the reclaimed wood bears the hallmarks of old wood with nicks, imperfections, marks that reveal the stool's provenance. further enhancing its rustic character.



Finish: Reclaimed Wood -
Old Pine, Rustic Iron

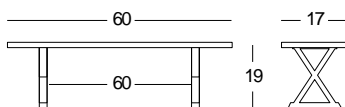

carton size: overall: 61"w 19"d 7"h

carton Weight: 36 lbs

carton cube: 4.70cu.ft.

Packed: 1 item/carton

bench overall: 60"w 17"d 19"h. seat: 17"d 19"h.

resimercial
Furniture

DESIGN FOR TODAY

 double corner blocks: glued & screwed

 high density foam seats: contract quality

stb
7817

norton

bench **stb78172**

The backless silhouette is perfectly proportioned for the foot of a bed, the entryway or an open seating arrangement. The comfortably padded hardwood frame is artisan crafted. The cover is expertly upholstered with legs that are slightly curved, giving this eye-catching piece a modern touch.



Cover: Move. Colour: Stone.
Finish: Espresso.

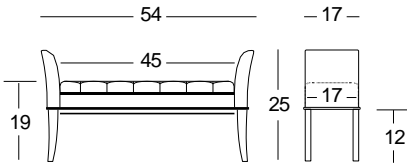

carton size: overall: 55"w 17"d 26"h

carton Weight: 29 lbs

carton cube: 14.15cu.ft.

Packed: 2 items/carton

bench overall: 54"w 17"d 25"h. seat: 45"w 17"d 19"h.

 double corner blocks: glued & screwed

 high density foam seats: contract quality

skd
363

didi

tufted bench **skd36349**

The backless silhouette is perfectly proportioned for the foot of a bed, the entryway or an open seating arrangement. The comfortably padded hardwood frame is artisan crafted. The cover is expertly upholstered with legs that are slightly curved, giving this eye-catching piece a modern touch.



Cover: Velour. Colour: Charcoal.
Finish: Espresso.

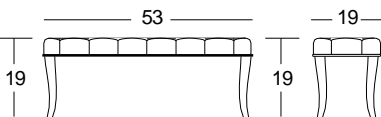

carton size: overall: 57"w 20"d 7"h

carton Weight: 26 lbs

carton cube: 4.29cu.ft.

Packed: 1 items/carton

bench overall: 53"w 19"d 19h. seat: 19"d 19"h.



reclaimed Timber: hand sanded & finished



kiln-dried Timber



metal: 30% recycled content

sc
511

quill

Wall shelf sc511

iron frame for an industrial imperfect look. This item is artisan crafted. The patina of the reclaimed wood bears the hallmarks of old wood with nicks, imperfections, marks that reveal the furniture's provenance. knots, gouges, cracks, nail holes, cupping and/or slight bowing are inherent characteristics of this wood product and does not constitute damage/defects. claims will not be considered for these characteristics.

Finish: Reclaimed Wood - Old Oak, Rustic Iron.

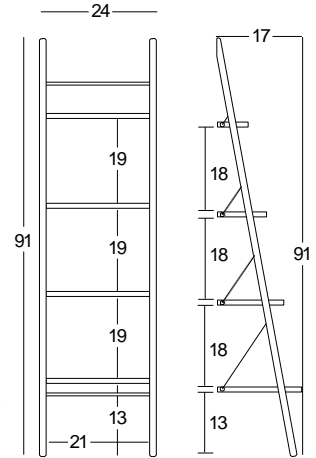

carton size: overall: 26"w 3"d 92"h
carton cube: 5.30 cu.ft.

carton Weight: 46 lbs
Packed: 1 item/carton

wall shelf overall: 24"w 17"d 91"h.



reclaimed Timber: hand sanded & finished



kiln-dried Timber



metal: 30% recycled content

sc
512

quill

Wall shelf sc512

iron frame for an industrial imperfect look. This item is artisan crafted. The patina of the reclaimed wood bears the hallmarks of old wood with nicks, imperfections, marks that reveal the furniture's provenance. knots, gouges, cracks, nail holes, cupping and/or slight bowing are inherent characteristics of this wood product and does not constitute damage/defects. claims will not be considered for these characteristics.

Finish: Reclaimed Wood - Old Oak, Rustic Iron.

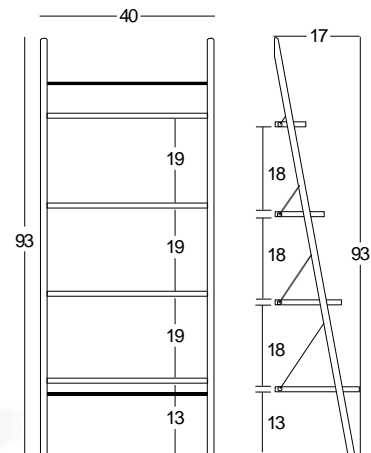

carton size: overall: 41"w 3"d 93"h
carton cube: 6.35 cu.ft.

carton Weight: 68 lbs
Packed: 1 item/carton

wall shelf overall: 40"w 17"d 93"h.



reclaimed Timber: hand sanded & finished



kiln-dried Timber



metal: 30% recycled content

sc
494

noe

PlasMa unit **sc494**

iron frame for an industrial imperfect look. This item is artisan crafted. The patina of the reclaimed wood bears the hallmarks of old wood with nicks, imperfections, marks that reveal the furniture's provenance. knots, gouges, cracks, nail holes, cupping and/or slight bowing are inherent characteristics of this wood product and does not constitute damage/defects. claims will not be considered for these characteristics.

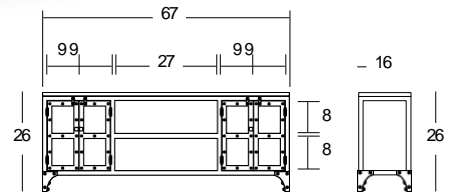

Finish: Reclaimed Wood - Old Elm, Rustic Iron.

carton size: overall: 68" w 17" d 28" h

carton Weight: 136 lbs

carton cube: 18.73 cu.ft.

Packed: 1 item/carton

desk overall: 54" w 16" d 26" h. desk Top: 31" h. 2 doors.



reclaimed Timber: hand sanded & finished



kiln-dried Timber

sc
1492

gusto

floor Mirror **sc1492**

The slightly ornate frame on the gusTo floor mirror pushes it ever so slightly away from the our "inspired by nature" concept. its traditional rustic contemporary look with a twist of modern, minimalist styling retains the organic feel of the reclaimed wood. while the combination of attributes and styling makes for a bold, yet delicate statement. The patina of the reclaimed wood bears the hallmarks of old wood with nicks, imperfections, marks that reveal the tables provenance. further enhancing its rustic character; cracks, cupping or slight bowing may be present.

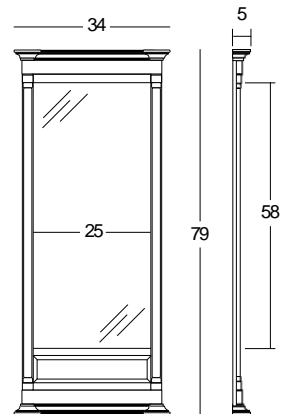

Finish: Reclaimed Wood - Old Pine, Mirror.

carton size: overall: 81" w 45" d 5" h

carton Weight: 48 lbs

carton cube: 10.55 cu.ft.

Packed: 1 item/carton

mirror overall: 34" w 5" d 79" h.



reclaimed Timber: hand sanded & finished



kiln-dried Timber



metal: 30% recycled content

asc
1727

nicky

lift toP accent table **sc1698**

iron frame for an industrial imperfect look. This item is artisan crafted. The patina of the reclaimed wood bears the hallmarks of old wood with nicks, imperfections, marks that reveal the furniture's provenance. knots, gouges, cracks, nail holes, cupping and/or slight bowing are inherent characteristics of this wood product and does not constitute damage/defects.

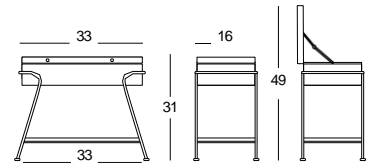

Finish: Reclaimed Wood - Old Pine, Rustic Iron.

carton size: overall: 38" w 19" d 32" h

carton cube: 10.24 cu.ft.

carton Weight: 25 lbs

Packed: 1 item/carton

accent table overall: 33" w 16" d 31" h.



reclaimed Timber: hand sanded & finished



kiln-dried Timber



metal: 30% recycled content

asc
1459

spencer

Media console/bookcase **sc1459**

iron frame for an industrial imperfect look. This item is artisan crafted. The patina of the reclaimed wood bears the hallmarks of old wood with nicks, imperfections, marks that reveal the furniture's provenance. knots, gouges, cracks, nail holes, cupping and/or slight bowing are inherent characteristics of this wood product and does not constitute damage/defects.

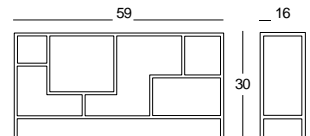

Finish: Reclaimed Wood - Old Pine, Rustic Iron.

carton size: overall: 61" w 18" d 32" h

carton cube: 18.36 cu.ft.

carton Weight: 65 lbs

Packed: 1 item/carton

bookcase overall: 59" w 16" d 30" h. 6 open compartments.

resimercial
Furniture

DESIGN FOR TODAY



reclaimed Timber: hand sanded & finished



kiln-dried Timber



metal: 30% recycled content

sc
167

ripley

3-door buffet/sideboard **sc1677**

rough-hewn planks are carefully hand-selected, planed and sanded. The patina of the reclaimed wood bears the hallmarks of old wood with nicks, imperfections, marks that reveal the unit's provenance. knots, gouges, cracks, nail holes, cupping and/or slight bowing are inherent characteristics of this wood product and does not constitute damage/defects. claims will not be considered for these characteristics.



Finish: Reclaimed Wood (Old Pine), Rustic Iron.

Collection Includes:

Coffee table (SC1671),

End Table (SC1773),

Console Table (SC1672),

2-Door Chest (SC1678).

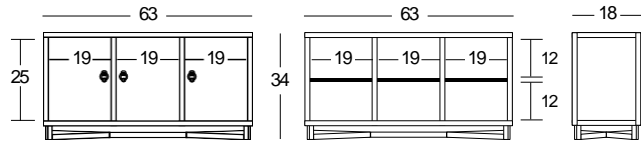

carton size: overall: 64"w 19"d 35"h

carton Weight: 117 lbs

carton cube: 24.83 cu.ft.

Packed: 1 item/carton

buffet/sideboard overall: 63"w 18"d 34"h. 3 doors.



reclaimed Timber: hand sanded & finished



kiln-dried Timber



metal: 30% recycled content

sc
167

ripley

2-door buffet/sideboard **sc1678**

rough-hewn planks are carefully hand-selected, planed and sanded. The patina of the reclaimed wood bears the hallmarks of old wood with nicks, imperfections, marks that reveal the unit's provenance. knots, gouges, cracks, nail holes, cupping and/or slight bowing are inherent characteristics of this wood product and does not constitute damage/defects. claims will not be considered for these characteristics.



Collection Includes: Coffee table (SC1671), End Table

(SC1673), Console Table (SC1672), 3-Door Chest (SC1677).

Finish: Reclaimed Wood - Old Pine, Rustic Iron, Antique Brass Handles.

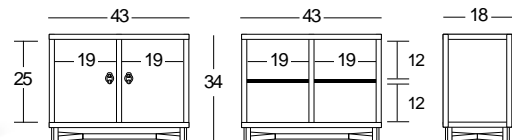

carton size: overall: 44"w 19"d 35"h

carton Weight: 88 lbs

carton cube: 19.33 cu.ft.

Packed: 1 item/carton

chest/sideboard overall: 43"w 18"d 34"h. 2 doors.



reclaimed Timber: hand sanded & finished



kiln-dried Timber



metal: 30% recycled content

sc
1727

argyle

3-door buffet/sideboard **sc1727**

rough-hewn planks are carefully hand-selected, planed and sanded. The patina of the reclaimed wood bears the hallmarks of old wood with nicks, imperfections, marks that reveal the tables provenance. knots, gouges, cracks, nail holes, cupping and/or slight bowing are inherent characteristics of this wood product and does not constitute damage/defects. claims will not be considered for these characteristics

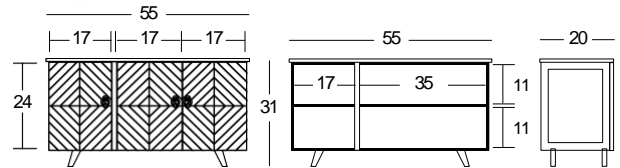

Finish: Reclaimed Wood - Old Pine, Rustic Iron.

carton size: overall: 57" w 21" d 32" h

carton Weight: 96 lbs

carton cube: 22.86 cu.ft.

Packed: 1 item/carton

buffet/sideboard overall: 55" w 20" d 31" h. 3 doors.



reclaimed Timber: hand sanded & finished



kiln-dried Timber



metal: 30% recycled content

sc
1721

cumberland

zinc top buffet/sideboard **sc1721**

a highly individual piece with a top plated in hammered zinc, this piece has been formed with sensitivity to produce a timeless, almost monolithic appearance that relies on classic shapes and controlled lines for its remarkable visual impact. knots, gouges, cracks, nail holes, cupping and/or slight bowing are inherent characteristics of this wood product.

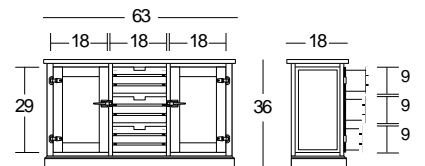

Finish: Reclaimed Wood - Old Pine, Rustic Iron, Antique Zinc.

carton size: overall: 64" w 20" d 36" h

carton Weight: 106 lbs

carton cube: 28.15 cu.ft.

Packed: 1 item/carton

buffet/sideboard overall: 63" w 18" d 36" h. 3 crated drawers.

resimercial
Furniture

DESIGN FOR TODAY



reclaimed Timber: hand sanded & finished



kiln-dried Timber



metal: 30% recycled content

sc
172

norita

3-door buffet/sideboard **sc1724**

iron frame for an industrial imperfect look. This item is artisan crafted. This collection bears the hallmarks of old reclaimed wood with nicks, imperfections and nail marks that reveal the buffet's provenance. given its handmade and hand-finished nature, variations in the wood or metal work, cupping and bowing are to be expected and celebrated.

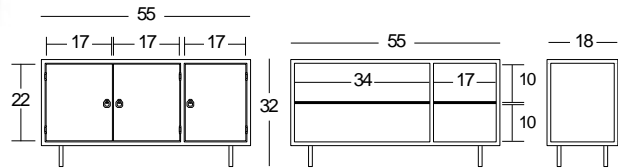

*Finish: Reclaimed Wood
- Old Elm, Rustic Iron,
Antique Brass Handles.*

carton size: overall: 57"w 19"d 33"h

carton Weight: 114 lbs

carton cube: 20.68 cu.ft.

Packed: 1 item/carton

buffet/sideboard overall: 55"w 18"d 32"h. 3 doors.



reclaimed Timber: hand sanded & finished



kiln-dried Timber



metal: 30% recycled content

sc
172

norita

2-door/2-drawer cabinet **sc1722**

iron frame for an industrial imperfect look. This item is artisan crafted. This collection bears the hallmarks of old reclaimed wood with nicks, imperfections and nail marks that reveal the cabinet's provenance. given its handmade and hand-finished nature, variations in the wood or metal work, cupping and bowing are to be expected and celebrated.



*Finish: Reclaimed Wood - Old Elm,
Rustic Iron, Antique Brass Handles.*

carton size: overall: 29"w 19"d 37"h

carton Weight: 106 lbs

carton cube: 10.50 cu.ft.

Packed: 1 item/carton

cabinet overall: 28"w 18"d 41"h. 2 doors, 2 drawers.

Outside Cabinet

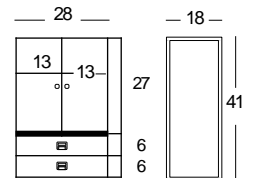

Inside Cabinet

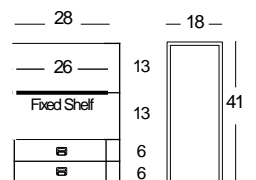



reclaimed Timber: hand sanded & finished



kiln-dried Timber



metal: 30% recycled content

sc
172

norita

6-draWer cabinet sc1723

iron frame for an industrial imperfect look. This item is artisan crafted. This collection bears the hallmarks of old reclaimed wood with nicks, imperfections and nail marks that reveal the cabinet's provenance. given its handmade and hand-finished nature, variations in the wood or metal work, cupping and bowing are to be expected and celebrated.

*Finish: Reclaimed Wood - Old Elm,
Rustic Iron, Antique Brass Handles.*

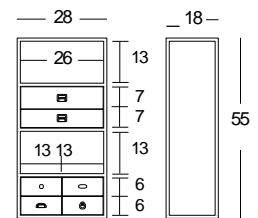

carton size: overall: 29" w 19" d 42" h

carton Weight: 143 lbs

carton cube: 17.86 cu.ft.

Packed: 1 item/carton

cabinet overall: 28" w 18" d 54" h. 6 drawers, 2 open shelves.



reclaimed Timber: hand sanded & finished



kiln-dried Timber



metal: 30% recycled content

sc
1242

roddy

boxcar buffet 98243

suddenly, everything you serve seems unexpected. pristinely crafted from a mix of kiln dried distressed wood and commercial grade metal composites, the highly livable boxcar buffet infuses a balanced breath of industrial livity. its strong character establishes a unique atmosphere in any dining or bar area. The multitone finish on distressed wood exudes a relaxed tone in the room and is complimented by rustic metal accents, exposed screws and open wheel, locking casters. This buffet features three shelves behind two barn-styled sliding doors and six drawers. plenty of storage space for all of your items.

*Finish: Reclaimed Acacia Wood
(Smokey Grey), Rustic Iron.*

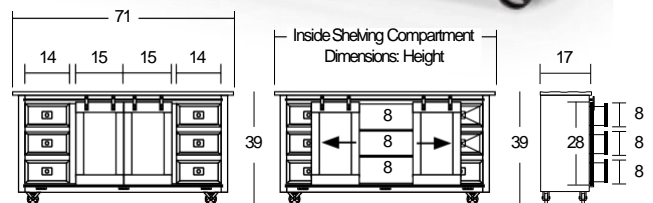

carton size: overall: 74" w 20" d 38" h

carton Weight: 188 lbs

carton cube: 32.33 cu.ft.

Packed: 1 item/carton

buffet overall: 71" w 17" d 39" h. 6 drawers, 2 sliding doors, 4 casters.

resimercial
Furniture

DESIGN FOR TODAY



reclaimed Timber: hand sanded & finished



kiln-dried Timber



metal: 30% recycled content

sc
1710

dublin

8-draWer chest/sideboard **sc1710**

rough-hewn planks are carefully hand-selected, planed and sanded. The patina of the reclaimed wood bears the hallmarks of old wood with nicks, imperfections, marks that reveal the chest's provenance. knots, gouges, cracks, nail holes, cupping and/or slight bowing are inherent characteristics of this wood product and does not constitute damage/defects. claims will not be considered for these characteristics.

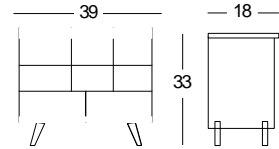

Finish: Reclaimed Wood - Old Elm, Rustic Iron - Knobs and Handles.

carton size: overall: 41" w 19" d 35" h

carton Weight: 101 lbs

carton cube: 15.76 cu.ft.

Packed: 1 item/carton

chest/sideboard overall: 39" w 18" d 33" h. 6 drawers.



reclaimed Timber: hand sanded & finished



kiln-dried Timber



metal: 30% recycled content

sc
1733

goddard

2-draWer chest/sideboard **sc1733**

bring a feel of the english countryside into your home with this rough, authentic 2-drawer chest. constructed from reclaimed old pine, it exudes a textured, rustic feel. The distressed nature of the chest along with the intricate weathered handles and dentil detailing make it an ideal space for those who appreciate simplistic designs. Two drawers line the front, acting as a great storage space.

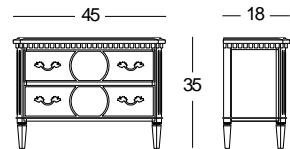

Finish: Reclaimed Wood - Old Pine, Antique Brass Handles.

carton size: overall: 46" w 20" d 36" h

carton Weight: 75 lbs

carton cube: 19.17 cu.ft.

Packed: 1 item/carton

chest/sideboard overall: 45" w 18" d 35" h. 2 drawers



reclaimed Timber: hand sanded & finished



kiln-dried Timber



metal: 30% recycled content

c2c
desk

luke

live-edge desk 98221

This two drawer acacia wood writing desk is perfect for your home office. The rich sandia brown finish brings the wood grain to life. The drawers have upgraded extended glides allowing for easier access to what's stored inside. if you look closely you will notice the natural live edge visible along the top cubby and lower edge of the drawers.



Finish: Acacia Wood - Sandia Brown, Cast Iron - Matte Black.

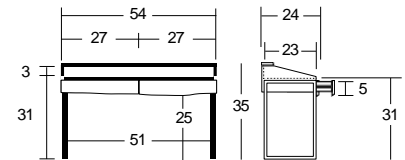

carton size: overall: 57" w 27" d 10" h
carton cube: 8.91 cu.ft.

carton Weight: 132 lbs
Packed: 1 item/carton

desk overall: 54" w 24" d 36" h. desk Top: 31" h. 2 drawers.



reclaimed Timber: hand sanded & finished



kiln-dried Timber



metal: 30% recycled content

c2c
desk

archie

live-edge desk 98222

create a stunning work space with the modern live-edge vintage desk. add a distinctive designer touch to any space, without the designer price tag. no matter where you place this desk, you'll love the stylish look it adds to any room.



Finish: Acacia Wood - Sandia Brown, Cast Iron - Matte Black.

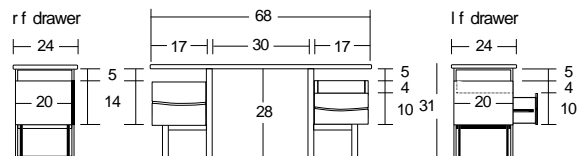

98222 table top carton size: overall: 70" w 28" d 4" h
table base carton size: overall: 40" w 22" d 32" h

desk overall: 68" w 24" d 31" h. 2 open shelves, 2 drawers
total Weight: 111 lbs total cube: 12.10 cu.ft.

Packed: 2/cartons/item

resimercial
Furniture

DESIGN FOR TODAY



reclaimed Timber: hand sanded & finished



kiln-dried Timber



metal: 30% recycled content

sc
1741

tucker

desk sc1741

iron frame for an industrial imperfect look. This item is artisan crafted. This collection bears the hallmarks of old reclaimed wood with nicks, imperfections and nail marks that reveal the desk's provenance. given its handmade and hand-finished nature, variations in the wood or metal work, cupping and bowing are to be expected and celebrated.



Finish: Reclaimed Wood (Old Elm),
Rustic Iron, Antique Brass Handles.

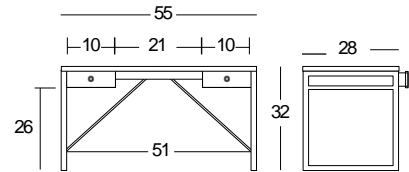

carton size: overall: 57" w 29" d 10" h

carton Weight: 106 lbs

carton cube: 9.57 cu.ft.

Packed: 1 item/carton

desk overall: 55" w 28" d 32" h.



reclaimed Timber: hand sanded & finished



kiln-dried Timber



metal: 30% recycled content

sc
1242

olie

x-base desk sc1242

iron frame for an industrial imperfect look. This item is artisan crafted. The patina of the reclaimed wood bears the hallmarks of old wood with nicks, imperfections, marks that reveal the furniture's provenance. knots, gouges, cracks, nail holes, cupping and/or slight bowing are inherent characteristics of this wood product and does not constitute damage/defects. claims will not be considered for these characteristics.



Finish: Reclaimed Wood (Old Pine),
Rustic Iron, Antique Brass Handles.

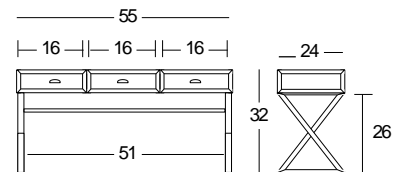

carton size: overall: 58" w 27" d 9" h

carton Weight: 60 lbs

carton cube: 8.16 cu.ft.

Packed: 1 item/carton

desk overall: 55" w 24" d 32" h. 3 drawers